

IGNIA
L I G H T





We design and manufacture solution with LED Technology
Diseñamos y fabricamos soluciones con tecnología LED

Founded
1999



Multinational
group



Growth
year on year



LED lighting
manufacturers



L80-60.000h



Energy saving



Certifications



IGNIA
LIGHT

Our company

SACOPA, a thermoplastics manufacturer, is part of the FLUIDRA group's industrial division, a multinational company specialized in creating perfect experiences for swimming pools and wellness centers.

Ignialight's installations include a state-of-

the-art lighting laboratory equipped with a goniophotometer, an integrating sphere and field measuring devices. All of this equipment is used by a team of engineers specialised in the research and development of products at the cutting-edge of technology.

Nuestra empresa

SACOPA es una empresa fabricante de termoplásticos que forma parte de la división industrial del grupo FLUIDRA. Empresa multinacional especialista en crear experiencias perfectas para piscinas y wellness.

Las instalaciones de Ignialight disponen de un laboratorio lumínico de última generación

equipado con goniofotómetro, esfera de integración y dispositivos de medición de campo. Todo ello gestionado por ingenieros especializados en la investigación y desarrollo de productos punteros tecnológicamente.

IGNIA
LIGHT

IGNIA
LIGHT

Ignialight's world

In 1999, diversification, research and development led SACOPA to create the IGNIALIGHT brand, which specializes in the design, development and manufacture of LED lighting products. Focusing on decorative fountain projects, IGNIALIGHT creates end-to-end lighting experiences.

IGNIALIGHT's cutting-edge facilities include a state-of-the-art light laboratory equipped

with goniophotometer, integrating sphere and field measuring devices, all managed by skilled engineers with extensive experience.

All of this makes IGNIALIGHT a reliable partner for the most technically demanding projects. Our products are involved in an ongoing process of improvement and updating that harnesses the most efficient and advanced technology.

Likewise, we adapt and customize our products to the requirements of large projects and their specifications to fully meet our customers needs. This has made the company's internationalization possible, and IGNIALIGHT now delivers lighting solutions with LED technology for major projects worldwide.

Nuestra marca

En 1999, fruto de la diversificación, el desarrollo y la investigación, SACOPA crea la marca IGNIALIGHT, especializada en el diseño, desarrollo y fabricación de productos de iluminación con tecnología LED. Centrada en proyectos de fuentes ornamentales y su entorno, IGNIALIGHT crea experiencias completas en iluminación.

Con instalaciones tecnológicamente punteras, IGNIALIGHT dispone de un laboratorio lumínico de

última generación equipado con goniofotómetro, esfera de integración y dispositivos de medición de campo. Todo ello gestionado por ingenieros especializados con amplia experiencia.

Esta coyuntura hace que IGNIALIGHT sea un partner de confianza para los proyectos técnicamente más exigentes. En un proceso de mejora y actualización constante nuestros productos disponen de la tecnología más eficiente y avanzada. Asimismo,

adaptamos y personalizamos nuestros productos conforme a las exigencias de los grandes proyectos y sus especificidades, atendiendo de esta manera las necesidades del cliente.

El conjunto de estos elementos nos ha permitido internacionalizar la compañía, aportando soluciones lumínicas con tecnología LED en importantes proyectos a nivel mundial.

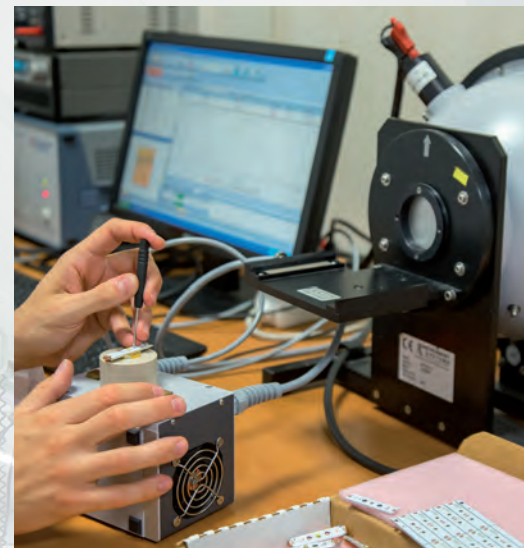

Services/ Customer service

Our technical/sales department shares the initial concepts, evaluation, and assessment of each project with the customer, setting in motion a process that involves the Technical Office's thorough assessment of the customer's requirements. The resulting synergies and corresponding needs and specification analysis makes it possible for us to provide the ideal solution for each project.

Our R&D team consists of a Technical Office with over 15 engineers, a state-of-the-art light laboratory and cutting-edge facilities.

The light laboratory generates the technical information we need on each product in order to design and develop the best solution for each application.

The goniophotometer generates the photometric files that we use in the lighting studies of each installation. With this information we can perform simulations and calculate a project's actual lighting level; it also helps our technicians adjust the lighting distribution in the space provided, thus ensuring an outstanding lighting level, uniformity, and optimal consumption.

Servicios/ Atención al Cliente

Nuestro departamento técnico-comercial comparte con los clientes los conceptos iniciales de cada proyecto, su evaluación y valoración, ejerciendo de cadena de tracción hacia la oficina técnica para un completo análisis de las necesidades de este. A partir de las sinergias generadas y el correspondiente análisis de requerimientos y especificaciones, aportamos la solución ideal para cada proyecto.

Nuestro equipo de I+D está compuesto por una Oficina Técnica con más de 15 ingenieros, laboratorio lumínico de última generación e instalaciones

tecnológicamente punteras.

Del laboratorio lumínico obtenemos la información técnica de cada producto para definir y desarrollar la mejor solución para cada aplicación.

El goniofotómetro genera los ficheros fotométricos que utilizamos en los estudios lumínicos de cada instalación. Esta información permite realizar simulaciones y calcular el nivel de iluminación real que tendrá el proyecto además de ayudar a nuestros técnicos a ajustar la distribución de las luminarias en el espacio a iluminar.





Values, quality and commitment

IGNIALIGHT creates the perfect experience for your lighting project. All IGNIALIGHT project management and services integrate aspects of quality, safety and environmental protection in order to deliver products that fully satisfy the customer's needs and expectations while also ensuring the safety and health of our employees.

Incorporating the best parts and materials on the market, together with exhaustive quality controls and the implementation of the LEAN methodology

to continuously improve processes, translates into product excellence.

This commitment to excellence is evidenced by our certification to the ISO 9001 and ISO 14001 standards for quality management systems and our adhesion to Regulation (EC) No 1221/2009 of the European Parliament and of the Council, voluntarily participating in an eco-management and audit scheme (EMAS).

The FLUIDRA group's extensive history, with over 50 years of experience in the industrial sector, guarantees our customers a commitment to the future. We are members of the CEI (Spanish Lighting Committee), CICAT (Cluster of Lighting Manufacturers) and SECARTYS (Spanish Association for the Internationalization of the Electronics, Information Technology and Telecommunications Companies).

Valores, calidad y compromiso

Ignialight crea la experiencia perfecta en su proyecto de iluminación. Integra en toda su gestión, actividades y productos aspectos de calidad, seguridad y medioambiente, con el fin de ofrecer productos que satisfagan plenamente las necesidades y expectativas de nuestros clientes, asegurando la eficiencia la seguridad y la salud de nuestros trabajadores.

La elección de los mejores componentes y materiales junto con exhaustivos controles de calidad

y la implantación de la metodología LEAN para la mejora continua de procesos, nos permite obtener la excelencia en nuestros productos.

Garantía de ello es la certificación de nuestra gestión integrada según las normas ISO 9001 e ISO14001; la adhesión voluntaria al Reglamento (CE) núm. 1221/2009 del Parlamento y el Consejo Europeo, de gestión y auditoría medioambiental (EMAS).

La larga trayectoria del grupo FLUIDRA, con más de 50 años de experiencia en el sector industrial, garantiza a nuestros clientes un compromiso de futuro. Formamos parte del CEI (Comité Español de Iluminación), CICAT (Clúster de fabricantes de iluminación) y SECARTYS.



IGNIALIGHT products

We focus our efforts on underwater and architectural lighting solutions. We design and manufacture high-quality products perfect for decorative fountains and public and private pools.

Our underwater and architectural range features a wide selection of lighting options in terms of concentration and diffusion. From the most focused 9° lens to ones with a flood of 100°, IGNIALIGHT products offer a range of options to adapt to the specific needs of each project.

In terms of colour temperatures, underwater and architectural projectors come in warm, neutral or cool colours, as well as multicolour or RGB models and RGBW, for ample choices to fit every situation.

Productos IGNIALIGHT

Apostamos por las soluciones lumínicas subacuáticas y arquitectónicas. Diseñamos y fabricamos productos de alta calidad ideales para ser instalados en fuentes ornamentales, piscinas públicas y privadas.

Nuestras gamas subacuática y arquitectónica destacan por su amplio rango de concentración y difusión de la luz. Las lentes más cerradas, de 9° hasta las más abiertas 100°, pasando por un amplio rango de opciones intermedias para adaptarse así a la necesidad propia de cada proyecto.

A nivel de temperaturas de color, los proyectores subacuáticos y arquitectónicos disponen del color cálido, neutro o frío, además de la opción de multicolor o RGB y RGBW, utilizando así la mejor opción para cada situación.

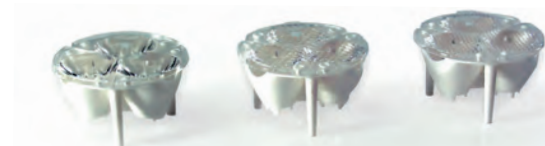

Wide lens range products cover 9° until 100°
Amplia cobertura de lentes con rango de apertura entre 9° y 100°.



3000°K
Warm White
Blanco cálido

4000°K
Neutral White
Blanco neutro

5700°K
Cool White
Blanco frío



Multicolour
Multicolor

Identification Identificación

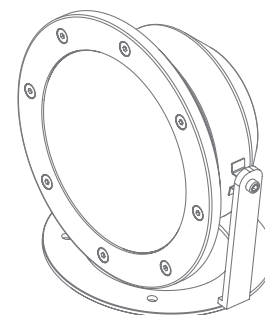

Product recommended for/ Producto recomendado para:

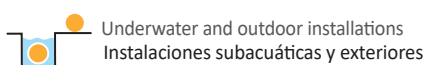
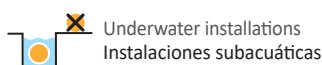

IP

First figure/ Primera cifra

Level of protection against the ingress of solid objects
Nivel de protección contra el ingreso de objetos sólidos

- 0 - No protection / No protegido
- 1 - Protection from solid objects with a diameter greater than 50mm / Protegidos contra los cuerpos sólidos cuya dimensión mayor sea superior a 50mm
- 2 - Protection from solid objects with a diameter greater than 12.5 mm / Protegidos contra los cuerpos sólidos cuya dimensión mayor sea superior a 12.5mm
- 3 - Protection from solid objects with a diameter greater than 2.5 mm / Protegidos contra los cuerpos sólidos cuya dimensión mayor sea superior a 2.5mm
- 4 - Protection from solid objects with a diameter greater than 1 mm / Protegidos contra los cuerpos sólidos cuya dimensión mayor sea superior a 1mm
- 5 - Protected from dust / Protegida contra el polvo
- 6 - Hermetic to dust / Hermética al polvo

Second figure/ Segunda cifra

Level of protection against ingress of water
Nivel de protección contra el ingreso de agua

- 0 - No protection / No protegido
- 1 - Dripping water/ Goteo de agua vertical
- 2 - Dripping water when tilted up to 15°/Goteo de agua en direcciones de 15°
- 3 - Spraying water/ Agua nebulizada
- 4 - Splashing water/ Chorros de agua
- 5 - Water jets/ Chorros de agua intensos
- 6 - Powerful water jets/ Chorros muy potentes de agua
- 7 - Protected from immersion effects / Protegida contra los efectos de inmersión
- 8 - Protection from prolonged immersion/ Protegida contra la inmersión prolongada

Class/Clase



Class I Luminaire in which the protection against electric shocks depends on the main insulation and an additional safety measure: earthing.

Clase I Luminaria en la que la protección contra los choques eléctricos recae sobre el aislamiento principal y una medida de seguridad complementaria: la puesta a tierra.



Class II Luminaire in which the protection against electric shocks depends on the main insulation and an additional safety measure: double or reinforced insulation.

Clase II Luminaria en la que la protección contra los choques eléctricos recae sobre el aislamiento principal y una medida de seguridad complementaria: el doble aislamiento o el aislamiento reforzado.



Class III Luminaire in which the protection against electric shocks depends on feeding it with a low voltage power supply.

Clase III Luminaria en la que la protección contra los choques eléctricos recae en alimentar esta con muy baja tensión de seguridad.



CE Marking/ Marcado CE

Underwater lighting
Iluminación subacuática



Halospot projector Proyector Halospot

High-resistance projector, made with stainless steel. It is ideal for ornamental fountains and water jets.

It should be installed completely submerged in water. It is provided with screws and studs for fitting. Possibility of narrow, medium or wide lens.

Proyector de alta resistencia, fabricado en acero inoxidable. Es ideal para fuentes ornamentales y surtidores de agua.

Debe ser instalado totalmente sumergido en agua. Se suministran tornillos y tacos para su fijación.

Disponible en óptica concentrada, media y abierta.

Consumption/ Consumo

Monocolour/ Monocolor: 22W (32VA)

Multicolour/ Multicolor: 22W (31VA)

MWDMX/ MWDMX: 30W (30VA)

Voltage/ Voltaje

Monocolour/ Monocolor: 12 Vac

Multicolour/ Multicolor: 12 Vac

MWDMX/ MWDMX: 24 Vdc

Lumens/ Lúmenes

Monocolour/ Monocolor: 2.052 lm

Multicolour/ Multicolor: 1.100 lm

MWDMX/ MWDMX: 1.750 lm

Efficiency/ Eficiencia

Monocolour/ Monocolor: 93,27 lm/W

Multicolour/ Multicolor: 50 lm/W

MWDMX/ MWDMX: 58,33 lm/W

Life Span/ Vida útil

L80 - 60.000h

Protection level/ Grado de Protección

IP68



I0403 Halospot projector
Proyector Halospot

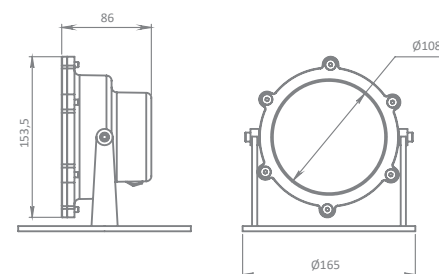

Code/ Código	Light/ Luz	Face Plate/ Embellecedor	Optic/ Óptica	Control/ Control
I0403	W Cool white Blanco frío WW Warm white Blanco cálido M Multicolour Multicolor MWDMX Multicolour White DMX Multicolor Blanco DMX	M Material Material P Plastic Plástico I Stainless Steel Acero Inox.	N Narrow Concentrada M Medium Media W Wide Abierta	Multicolour Multicolor 10826 Modulator Modulador 10828 Remote control Control Remoto 10831 Push-button Pulsador DMX 10832DMX DMX power supply Alimentador DMX 10832DMXFE DMX external power supply Alimentador DMX fuente externa
		S Shape/ Forma S Square Cuadrado R Round Redondo		

Kibele projector

Proyector Kibele

A large projector with high luminous performance. Made of stainless steel. Ideal for installation in ornamental fountains with jets with high flow rates. Possibility of narrow, medium or wide lens. It is supplied with screws and wall plugs.

Proyector de gran formato y de elevadas prestaciones lumínicas. Fabricado en acero inoxidable. Ideal para instalar en fuentes ornamentales con surtidores de gran caudal. Disponible en óptica concentrada, intermedia y abierta. Se suministran tornillos y tacos para su fijación.

Consumption/ Consumo

Monocolour/ Monocolor: 58W (60VA)
Multicolour/ Multicolor: 48W (64VA)
MWDMX/ MWDMX: 56W (56VA)

Voltage/ Voltaje

Monocolour/ Monocolor: 12 Vac
Multicolour/ Multicolor: 12 Vac
MWDMX/ MWDMX: 24 Vdc

Lumens/ Lúmenes

Monocolour/ Monocolor: 4.320 lm
Multicolour/ Multicolor: 2.544 lm
MWDMX/ MWDMX: 3.100 lm

Efficiency/ Eficiencia

Monocolour/ Monocolor: 74,4 lm/W
Multicolour/ Multicolor: 53 lm/W
MWDMX/ MWDMX: 56 lm/W

Life Span/ Vida útil

L80 - 60.000h

Protection level/ Grado de Protección

IP68



I0407 Kibele projector
Proyector Kibele

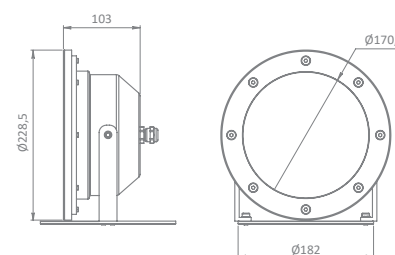

Code/ Código	Light/ Luz	Face Plate/ Embellecedor	Optic/ Óptica	Control/ Control
I0407	W Cool white Blanco frío WW Warm white Blanco cálido M Multicolour Multicolor MWDMX Multicolour White DMX Multicolor Blanco DMX	M Material / Material P Plastic Plástico I Stainless Steel Acero Inox.	N Narrow Concentrada M Medium Media W Wide Abierta	Multicolour Multicolor I0826 Modulator Modulador I0828 Remote control Control Remoto I0831 Push-button Pulsador DMX I0832DMX DMX power supply Alimentador DMX I0832DMXFE DMX external power supply Alimentador DMX fuente externa
		Shape/ Forma S Square Cuadrado R Round Redondo		

Directional projector Mini

Proyector Mini orientable



This spotlight is especially designed for fountains, gardens and decorative aquatic installations. It can be installed indiscriminately submerged or outside the water.

It is supplied with screws and studs for fitting. Possibility of narrow, medium or wide lens.

Este proyector está especialmente diseñado para instalarse en fuentes, jardines e instalaciones acuáticas decorativas. Se puede instalar indistintamente sumergido o fuera del agua.

Se suministran tornillos y tacos de fijación.

Disponible en óptica concentrada, media y abierta.

Consumption/ Consumo	Mini	Mini +
Monocolour/ Monocolor:	4W (6VA)	6W (9VA)
Multicolour/ Multicolor:	4W (7VA)	6W (9VA)
MDMX/ MDMX:	4W (4VA)	6W (6VA)
MWDMX/ MWDMX:	5W (5VA)	8W (8VA)

Voltage/ Voltaje

Monocolour/ Monocolor:	12 Vac	12 Vac
Multicolour/ Multicolor:	12 Vac	12 Vac
MDMX/ MDMX:	24 Vdc	24 Vdc
MWDMX/ MWDMX:	24 Vdc	24 Vdc

Lumens/ Lúmenes

Monocolour/ Monocolor:	315 lm	550 lm
Multicolour/ Multicolor:	186 lm	250 lm
MDMX/ MDMX:	186 lm	250 lm
MWDMX/ MWDMX:	300 lm	430 lm

Efficiency/ Eficiencia

Monocolour/ Monocolor:	78,7 lm/W	91,66lm/W
Multicolour/ Multicolor:	46,5 lm/W	55 lm/W
MDMX/ MDMX:	46,5 lm/W	55 lm/W
MWDMX/ MWDMX:	60 lm/W	53,75 lm/W

Life Span/ Vida útil

L80 - 60.000h

Protection level/ Grado de Protección

IP68 - IK10



- I0406 Directional projector Mini
Proyector Mini orientable
- I0411 Directional projector Mini+
Proyector Mini+ orientable

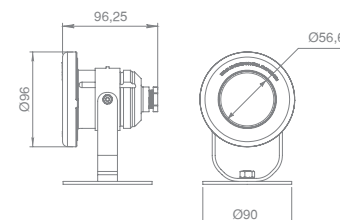

Code/ Código	Light/ Luz	Face Plate/ Embellecedor	Optic/ Óptica	Control/ Control
I0406	W Cool white Blanco frío	Material/ Material	N Narrow Concentrada	Multicolour Multicolor
I0411	WW Warm white Blanco cálido	P Plastic Plástico	M Medium Media	I0826 Modulator Modulador
	M Multicolour Multicolor	I Stainless Steel Acero Inox.	W Wide Abierta	I0828 Remote control Control Remoto
	MDMX Multicolour DMX Multicolor DMX	Shape/ Forma		I0831 Push-button Pulsador
	MWDMX Multicolour White DMX Multicolor Blanco DMX	S Square Cuadrado		DMX
		R Round Redondo		I0832DMX DMX power supply Alimentador DMX
				I0832DMXFE DMX external power supply Alimentador DMX fuente externa

Directional projector Nano Proyector Nano orientable



Small adjustable projector made of AISI 316 stainless steel, it is ideal for installation in ornamental fountains, gardens and decorative water features. May be installed both above or below the water. Possibility of narrow and wide lens. It is supplied with screws and wall plugs.

Proyector orientable de pequeñas dimensiones, fabricado en Acero inoxidable AISI 316, ideal para instalar en fuentes ornamentales, jardines o instalaciones acuáticas, decorativas. Puede ser instalado dentro o fuera del agua indistintamente. Posibilidad de óptica concentrada y abierta. Se suministra tornillos y tacos para su fijación.

Consumption/ Consumo

Monocolour/ Monocolor: 3W (4VA)
Multicolour/ Multicolor: 3W (4VA)
MDMX/ MDMX: 3W (3VA)

Voltage/ Voltaje

Monocolour/ Monocolor: 12 Vac
Multicolour/ Multicolor: 12 Vac
MDMX/ MDMX: 24 Vdc

Lumens/ Lúmenes

Monocolour/ Monocolor: 250 lm
Multicolour/ Multicolor: 150 lm
MDMX/ MDMX: 150 lm

Efficiency/ Eficiencia

Monocolour/ Monocolor: 83,3 lm/W
Multicolour/ Multicolor: 50 lm/W
MDMX/ MDMX: 50 lm/W

Life Span/ Vida útil

L80 - 60.000h

Protection level/ Grado de Protección

IP68



I0882 Directional projector Nano
Proyector Nano orientable

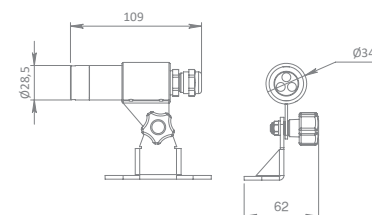

Code/ Código	Light/ Luz	Face Plate/ Embellecedor	Optic/ Óptica	Control/ Control
I0882	W Cool white Blanco frío WW Warm white Blanco cálido M Multicolour Multicolor MDMX Multicolour DMX Multicolor DMX	Material/ Material P Plastic Plástico I Stainless Steel Acero Inox.	N Narrow Concentrada M Medium Media W Wide Abierta	Multicolour Multicolor I0826 Modulator Modulador I0828 Remote control Control Remoto I0831 Push-button Pulsador DMX I0832DMX DMX power supply Alimentador DMX I0832DMXFE DMX external power supply Alimentador DMX fuente externa
		Shape/ Forma S Square Cuadrado R Round Redondo		



Circular Ø200

Circular Ø200



Projector designed for fitting directly to the jets of ornamental fountains, thus ensuring that they are properly illuminated and emit an even source of light.

Proyector diseñado para instalar directamente en surtidores de fuentes ornamentales y conseguir así una correcta y homogénea iluminación del surtidor de agua.

Consumption/ Consumo

Monocolour/ Monocolor: 16W
MWDMX/ MWDMX: 16W

Voltage/ Voltaje

24Vdc

Lumens/ Lúmenes

Monocolour/ Monocolor: 1.450 lm
MWDMX/ MWDMX: 1.000 lm

Efficiency/ Eficiencia

Monocolour/ Monocolor: 91 lm/W
MWDMX/ MWDMX: 62,5 lm/W

Life Span/ Vida útil

L80 - 60.000h

Protection level/ Grado de Protección

IP68



- I 1261 Circular Ø200 fijación rosca 1" 1/2
Circular Ø200 1" 1/2 fitting
- I 1262 Circular Ø200 fijación rosca 1"
Circular Ø200 1" fitting
- I 1263 Circular Ø200 sin rosca
Circular Ø200 non threaded fitting
- I 1264* Circular Ø200 empotrado
Circular Ø200 flat mounting
- I 1265* Circular Ø200 fuente seca
Circular Ø200 dry fountain

I1265

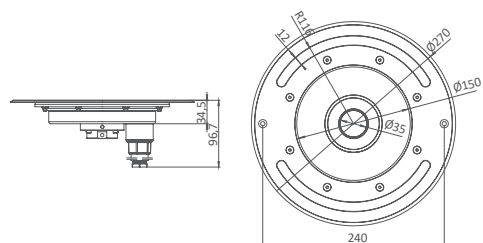

I1264

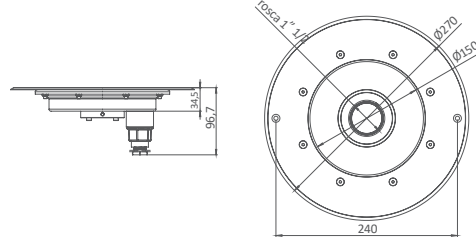

I1261

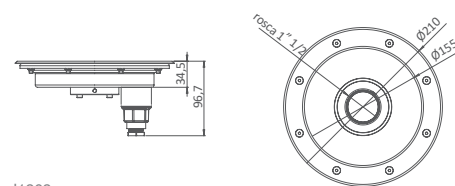

I1262

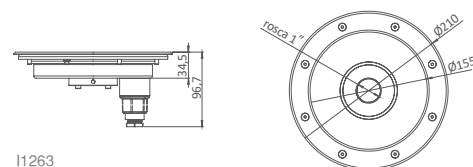

I1263

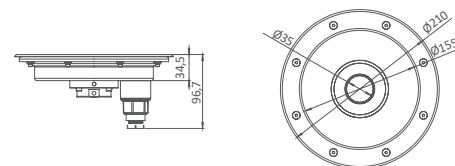

Code/ Código Light/ Luz

Face Plate/ Embellecedor

Optic/ Óptica

Control/ Control

I 1261 **W** Cool white | Blanco frío
I 1262 **WW** Warm white | Blanco cálido
I 1263 **MWDMX** Multicolour White DMX | Multicolor Blanco DMX
I 1264*
I 1265*

Material/ Material
P Plastic | Plástico
I Stainless Steel | Acero Inox.

N Narrow | Concentrada
M Medium | Media
W Wide | Abierta

Multicolour | Multicolor
I0826 Modulator | Modulador
I0828 Remote control | Control Remoto
I0831 Push-button | Pulsador
DMX
I0832DMX DMX power supply | Alimentador DMX
I0832DMXFE DMX external power supply | Alimentador DMX fuente externa

Shape/ Forma
S Square | Cuadrado
R Round | Redondo

* Consult mounting accessory / Consultar accesorio para montaje

Circular Ø300

Circular Ø300

A large projector with high luminous performance for fitting directly to the jets of ornamental fountains of up to 1" 1/2. Made of stainless steel.

Proyector de gran formato y de elevadas prestaciones lumínicas para instalar directamente en surtidores de fuentes ornamentales de hasta 1" 1/2. Fabricado en acero inoxidable.

Consumption/ Consumo

Monocolour/ Monocolor: 80W
MWDMX/ MWDMX: 80W

Voltage/ Voltaje

24Vdc

Lumens/ Lúmenes

Monocolour/ Monocolor: 7.200 lm
MWDMX/ MWDMX: 4.100 lm

Efficiency/ Eficiencia

Monocolour/ Monocolor: 90 lm/W
MWDMX/ MWDMX: 51 lm/W

Life Span/ Vida útil

L80 - 60.000h

Protection level/ Grado de Protección

IP68



I 1255 Circular Ø300
Circular Ø300

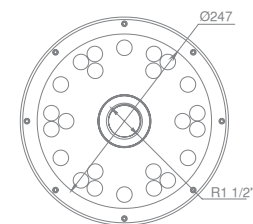
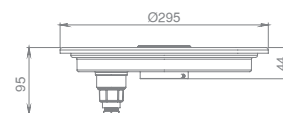

Code/ Código	Light/ Luz	Face Plate/ Embellecedor	Optic/ Óptica	Control/ Control
I 1255	W Cool white Blanco frío WW Warm white Blanco cálido MWDMX Multicolour White DMX Multicolor Blanco DMX	M Material/ Material P Plastic Plástico I Stainless Steel Acero Inox.	N Narrow Concentrada M Medium Media W Wide Abierta	Multicolour Multicolor 10828 Remote control Control Remoto 10826 Modulator Modulador DMX 10831 Push-button Pulsador 10832DMX DMX power supply Alimentador DMX 10832DMXFE DMX external power supply Alimentador DMX fuente externa
		Shape/ Forma S Square Cuadrado R Round Redondo		

Nano projector

Proyector Nano



The wall fitting despite its small dimensions offers a considerable light output. Ideal for signaling stairs in underwater, indoor and outdoor installations; where small dimensions are required.

Made of AISI 316 stainless steel with protection degree IP68. Possibility of intensive or extensive lens.

Aplique que pese a sus reducidas dimensiones ofrece una luminosidad muy considerable. Ideal para señalización en peldaños de escalera o instalaciones acuáticas, interiores o exteriores donde se requiera un proyector muy pequeño.

Fabricado en acero inoxidable AISI 316 y con un grado de protección IP68. Disponible en óptica concentrada y abierta.

Consumption/ Consumo

Monocolour/ Monocolor: 3W (4VA)
Multicolour/ Multicolor: 3W (4VA)
MDMX/ MDMX: 3W (3VA)

Voltage/ Voltaje

Monocolour/ Monocolor: 12 Vac
Multicolour/ Multicolor: 12 Vac
MDMX/ MDMX: 24 Vdc

Lumens/ Lúmenes

Monocolour/ Monocolor: 250 lm
Multicolour/ Multicolor: 150 lm
MDMX/ MDMX: 150 lm

Efficiency/ Eficiencia

Monocolour/ Monocolor: 83,3 lm/W
Multicolour/ Multicolor: 50 lm/W
MDMX/ MDMX: 50 lm/W

Life Span/ Vida útil

L80 - 60.000h

Protection level/ Grado de Protección

IP68



- I 1234 Nano projector Ø40
Proyector Nano Ø40
- I 1254 Nano projector Ø80
Proyector Nano Ø80
- I 1239 Nano projector with joints
Proyector Nano con juntas
- I 1247 Nano projector 1"
Proyector Nano 1"

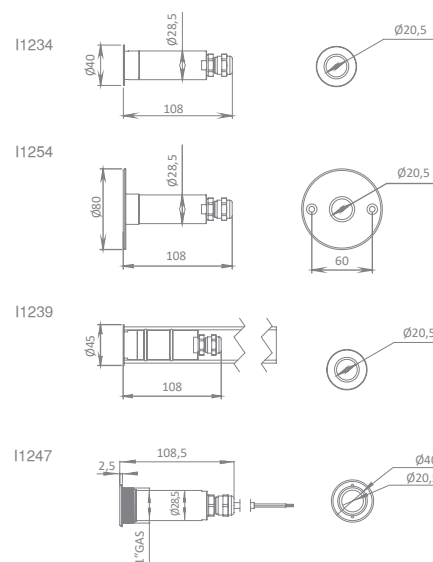

Code/ Código	Light/ Luz	Face Plate/ Embellecedor	Optic/ Óptica	Control/ Control
I 1234	W Cool white Blanco frío	Material/ Material	N Narrow Concentrada	Multicolour Multicolor
I 1254	WW Warm white Blanco cálido	P Plastic Plástico	M Medium Media	I0826 Modulator Modulador
I 1239	M Multicolour Multicolor	I Stainless Steel Acero Inox.	W Wide Abierta	I0828 Remote control Control Remoto
I 1247	MDMX Multicolour DMX Multicolor DMX	Shape/ Forma		I0831 Push-button Pulsador
		S Square Cuadrado		DMX
		R Round Redondo		I0832DMX DMX power supply Alimentador DMX
				I0832DMXFE DMX external power supply Alimentador DMX fuente externa

Mini projector Proyector Mini



The Mini OnLED projector is the best choice for lighting corners, small pools and SPAs.

El proyector Mini OnLED es la mejor opción para iluminar esquinas, piscinas pequeñas y SPAs.

Consumption/ Consumo	Mini	Mini +
Monocolour/ Monocolor:	4W (6VA)	6W (9VA)
Multicolour/ Multicolor:	4W (7VA)	6W (9VA)
MDMX/ MDMX:	4W (4VA)	6W (6VA)
MWDMX/ MWDMX:	5W (5VA)	8W (8VA)

Voltage/ Voltaje	Mini	Mini +
Monocolour/ Monocolor:	12 Vac	12 Vac
Multicolour/ Multicolor:	12 Vac	12 Vac
MDMX/ MDMX:	24 Vdc	24 Vdc
MWDMX/ MWDMX:	24 Vdc	24 Vdc

Lumens/ Lúmenes	Mini	Mini +
Monocolour/ Monocolor:	315 lm	550 lm
Multicolour/ Multicolor:	186 lm	250 lm
MDMX/ MDMX:	186 lm	250 lm
MWDMX/ MWDMX:	300 lm	430 lm

Efficiency/ Eficiencia	Mini	Mini +
Monocolour/ Monocolor:	78,7 lm/W	91,66 lm/W
Multicolour/ Multicolor:	46,5 lm/W	55 lm/W
MDMX/ MDMX:	46,5 lm/W	55 lm/W
MWDMX/ MWDMX:	60 lm/W	53,75 lm/W

Life Span/ Vida útil

L80 - 60.000h

Protection level/ Grado de Protección

IP68



- I0306 Mini projector quick coupling
Proyector Mini acople rápido
- I0307 Mini projector for SPAs
Proyector Mini para SPAs
- I0321 Mini + projector quick coupling
Proyector Mini + acople rápido
- I0322 Mini + projector for SPAs
Proyector Mini + para SPAs

I0306/ I0321

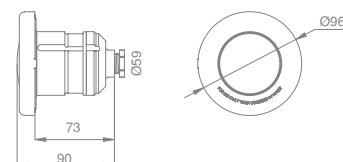

I0307/ I0322

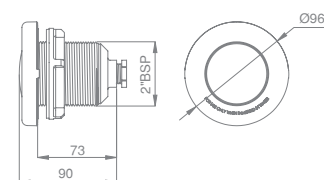

Code/ Código	Light/ Luz	Face Plate/ Embellecedor	Optic/ Óptica	Control/ Control
I0306	W Cool white Blanco frío	Material/ Material	N Narrow Concentrada	Multicolour Multicolor
I0307	WW Warm white Blanco cálido	P Plastic Plástico	M Medium Media	I0826 Modulator Modulador
I0321	M Multicolour Multicolor	I Stainless Steel Acero Inox.	W Wide Abierta	I0828 Remote control Control Remoto
I0322	MDMX Multicolour DMX Multicolor DMX	Shape/ Forma		I0831 Push-button Pulsador
	MWDMX Multicolour White DMX Multicolor Blanco DMX	S Square Cuadrado		DMX
		R Round Redondo		I0832DMX DMX power supply Alimentador DMX
				I0832DMXFE DMX external power supply Alimentador DMX fuente externa

Recessed projector with housing

Proyector enrasado con nicho



Projector designed for installation in pools and water features. Its lens and AISI 316 stainless steel faceplate have been designed to withstand a static load of up to 500 kg.

Estos proyectores están concebidos para instalarse en piscinas o espacios acuáticos. Su lente de vidrio y embellecedor de acero inoxidable AISI 316 están diseñados para aguantar 500 Kgr. de carga estática.

Consumption/ Consumo	Mini	Mini +
Monocolour/ Monocolor:	4W (6VA)	6W (9VA)
Multicolour/ Multicolor:	4W (7VA)	6W (9VA)
MDMX/ MDMX:	4W (4VA)	6W (6VA)
MWDMX/ MWDMX:	5W (5VA)	8W (8VA)

Voltage/ Voltaje

Monocolour/ Monocolor:	12 Vac	12 Vac
Multicolour/ Multicolor:	12 Vac	12 Vac
MDMX/ MDMX:	24 Vdc	24 Vdc
MWDMX/ MWDMX:	24 Vdc	24 Vdc

Lumens/ Lúmenes

Monocolour/ Monocolor:	315 lm	550 lm
Multicolour/ Multicolor:	186 lm	250 lm
MDMX/ MDMX:	186 lm	250 lm
MWDMX/ MWDMX:	300 lm	430 lm

Efficiency/ Eficiencia

Monocolour/ Monocolor:	78,7 lm/W	91,66 lm/W
Multicolour/ Multicolor:	46,5 lm/W	55 lm/W
MDMX/ MDMX:	46,5 lm/W	55 lm/W
MWDMX/ MWDMX:	60 lm/W	53,75 lm/W

Life Span/ Vida útil

L80 - 60.000h

Protection level/ Grado de Protección

IP68 - IK10



- I 1227 Mini recessed projector with housing concrete pool
Proyector Mini enrasado nicho piscina hormigón
- I 1283 Mini+ recessed projector with housing concrete pool
Proyector Mini+ enrasado nicho piscina hormigón

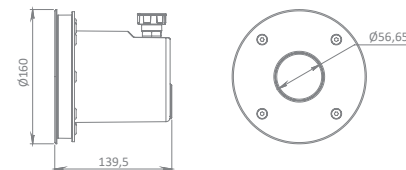

Code/ Código	Light/ Luz	Face Plate/ Embellecedor	Optic/ Óptica	Control/ Control
I 1227	W Cool white Blanco frío	Material/ Material	N Narrow Concentrada	Multicolour Multicolor
I 1283	WW Warm white Blanco cálido	P Plastic Plástico	M Medium Media	I0826 Modulator Modulador
	M Multicolour Multicolor	I Stainless Steel Acero Inox.	W Wide Abierta	I0828 Remote control Control Remoto
	MDMX Multicolour DMX Multicolor DMX	Shape/ Forma		I0831 Push-button Pulsador
	MWDMX Multicolour White DMX Multicolor Blanco DMX	S Square Cuadrado		DMX
		R Round Redondo		I0832DMX DMX power supply Alimentador DMX
				I0832DMXFE DMX external power supply Alimentador DMX fuente externa

Mini projector with housing Proyector Mini con nicho



An easy-to-install projector with high luminous intensity and improved energy efficiency.

Proyector de fácil instalación con una gran intensidad lumínica y mejor eficiencia energética.

Consumption/ Consumo	Mini	Mini +
Monocolour/ Monocolor:	4W (6VA)	6W (9VA)
Multicolour/ Multicolor:	4W (7VA)	6W (9VA)
MDMX/ MDMX:	4W (4VA)	6W (6VA)
MWDMX/ MWDMX:	5W (5VA)	8W (8VA)

Voltage/ Voltaje	Mini	Mini +
Monocolour/ Monocolor:	12 Vac	12 Vac
Multicolour/ Multicolor:	12 Vac	12 Vac
MDMX/ MDMX:	24 Vdc	24 Vdc
MWDMX/ MWDMX:	24 Vdc	24 Vdc

Lumens/ Lúmenes	Mini	Mini +
Monocolour/ Monocolor:	315 lm	550 lm
Multicolour/ Multicolor:	186 lm	250 lm
MDMX/ MDMX:	186 lm	250 lm
MWDMX/ MWDMX:	300 lm	430 lm

Efficiency/ Eficiencia	Mini	Mini +
Monocolour/ Monocolor:	78,7 lm/W	91,66 lm/W
Multicolour/ Multicolor:	46,5 lm/W	55 lm/W
MDMX/ MDMX:	46,5 lm/W	55 lm/W
MWDMX/ MWDMX:	60 lm/W	53,75 lm/W

Life Span/ Vida útil

L80 - 60.000h

Protection level/ Grado de Protección

IP68



- I0308 Mini projector with housing concrete pool
Proyector Mini con nicho piscina hormigón
- I0309 Mini projector with housing prefabricated pool
Proyector Mini con nicho piscina prefabricada
- I0323 Mini+ projector with housing concrete pool
Proyector Mini+ con nicho piscina hormigón
- I0324 Mini+ projector with housing prefabricated pool
Proyector Mini+ con nicho piscina prefabricada

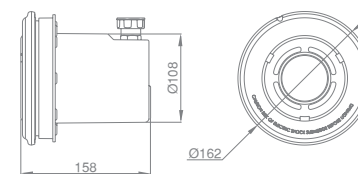

Code/ Código	Light/ Luz	Face Plate/ Embellecedor	Optic/ Óptica	Control/ Control
I0308	W Cool white Blanco frío	Material/ Material	N Narrow Concentrada	Multicolour Multicolor
I0309	WW Warm white Blanco cálido	P Plastic Plástico	M Medium Media	I0826 Modulator Modulador
I0323	M Multicolour Multicolor	I Stainless Steel Acero Inox.	W Wide Abierta	I0828 Remote control Control Remoto
I0324	MDMX Multicolour DMX Multicolor DMX	Shape/ Forma		I0831 Push-button Pulsador
	MWDMX Multicolour White DMX Multicolor Blanco DMX	S Square Cuadrado		DMX
		R Round Redondo		I0832DMX DMX power supply Alimentador DMX
				I0832DMXFE DMX external power supply Alimentador DMX fuente externa

Mini projector for niche Proyector Mini para nicho



An easy-to-install projector with high luminous intensity and improved energy efficiency.

Proyector de fácil instalación con una gran intensidad lumínica y mejor eficiencia energética.

Consumption/ Consumo	Mini
Monocolour/ Monocolor:	4W (6VA)
Multicolour/ Multicolor:	4W (7VA)
MDMX/ MDMX:	4W (4VA)
MWDMX/ MWDMX:	5W (5VA)

Voltage/ Voltaje	
Monocolour/ Monocolor:	12 Vac
Multicolour/ Multicolor:	12 Vac
MDMX/ MDMX:	24 Vdc
MWDMX/ MWDMX:	24 Vdc

Lumens/ Lúmenes	
Monocolour/ Monocolor:	315 lm
Multicolour/ Multicolor:	186 lm
MDMX/ MDMX:	186 lm
MWDMX/ MWDMX:	300 lm

Efficiency/ Eficiencia	
Monocolour/ Monocolor:	78,7 lm/W
Multicolour/ Multicolor:	46,5 lm/W
MDMX/ MDMX:	46,5 lm/W
MWDMX/ MWDMX:	60 lm/W

Life Span/ Vida útil	
	L80 - 60.000h

Protection level/ Grado de Protección

IP68



I0325

Mini projector
Proyector Mini

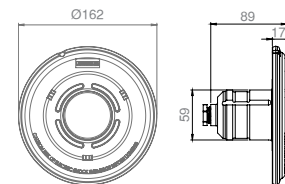

Code/ Código	Light/ Luz	Face Plate/ Embellecedor	Optic/ Óptica	Control/ Control
I0325	W Cool white Blanco frío WW Warm white Blanco cálido M Multicolour Multicolor MDMX Multicolour DMX Multicolor DMX MWDMX Multicolour White DMX Multicolor Blanco DMX	M Material Material P Plastic Plástico I Stainless Steel Acero Inox. S Shape/ Forma S Square Cuadrado R Round Redondo	N Narrow Concentrada M Medium Media W Wide Abierta	Multicolour Multicolor I0826 Modulator Modulador I0828 Remote control Control Remoto I0831 Push-button Pulsador DMX I0832DMX DMX power supply Alimentador DMX I0832DMXFE DMX external power supply Alimentador DMX fuente externa

Niq projector

Proyector Niq



The NIQ is used for SPAs, wellness centres, stairs. It has the same function as the Mini projector but with smaller dimensions.

El NIQ se utiliza para SPAs, wellness, escaleras. Tiene la misma funcionalidad que el proyector Mini pero con unas dimensiones mucho menores.

Consumption/ Consumo

Monocolour/ Monocolor: 4W (6VA)
Multicolour/ Multicolor: 4W (7VA)
MDMX/ MDMX: 4W (4VA)

Voltage/ Voltaje

Monocolour/ Monocolor: 12 Vac
Multicolour/ Multicolor: 12 Vac
MDMX/ MDMX: 24 Vdc

Lumens/ Lúmenes

Monocolour/ Monocolor: 315 lm
Multicolour/ Multicolor: 186 lm
MDMX/ MDMX: 186 lm

Efficiency/ Eficiencia

Monocolour/ Monocolor: 52,5 lm/W
Multicolour/ Multicolor: 46,5 lm/W
MDMX/ MDMX: 46,5 lm/W

Life Span/ Vida útil

L80 - 60.000h

Protection level/ Grado de Protección

IP68



- I0318 OnLED Niq projector "push fit"
Proyector Niq OnLED acople rápido
- I0319 OnLED Niq projector for SPAs
Proyector Niq OnLED para SPAs

I0318

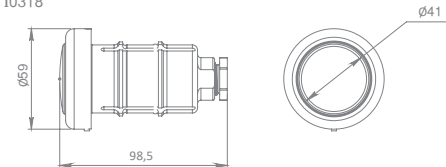

I0319

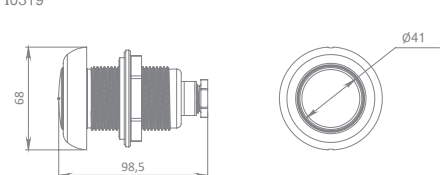

Code/ Código	Light/ Luz	Face Plate/ Embellecedor	Optic/ Óptica	Control/ Control
I0318	W Cool white Blanco frío	Material/ Material	N Narrow Concentrada	Multicolour Multicolor
I0319	WW Warm white Blanco cálido	P Plastic Plástico	M Medium Media	I0826 Modulator Modulador
	M Multicolour Multicolor	I Stainless Steel Acero Inox.	W Wide Abierta	I0828 Remote control Control Remoto
	MDMX Multicolour DMX Multicolor DMX	Shape/ Forma		I0831 Push-button Pulsador
		S Square Cuadrado		DMX
		R Round Redondo		I0832DMX DMX power supply Alimentador DMX
				I0832DMXFE DMX external power supply Alimentador DMX fuente externa

Broc STD projector Proyector Broc STD

Projector made entirely of engineering plastics, it is ideal for fitting to any type of nozzle or pool. Very easy to install and suitable for salt water pools. Choice of RGB or Wireless controls (I0504, I0505, I0506, I0508, I0509, I0510).

Proyector fabricado íntegramente con plásticos técnicos, ideal para instalar en todo tipo de boquillas y piscinas.

De muy fácil instalación y apto para piscinas de agua salada.

Posibilidad de control RGB o control Wireless (I0504, I0505, I0506, I0508, I0509, I0510).

Consumption/ Consumo

Monocolour/ Monocolor: 16W (24VA)

Multicolour/ Multicolor: 27W (37VA)

Voltage/ Voltaje

12 Vac

Lumens/ Lúmenes

Monocolour/ Monocolor: 1.485 lm

Multicolour/ Multicolor: 1.100 lm

Efficiency/ Eficiencia

Monocolour/ Monocolor: 92,8 lm/W

Multicolour/ Multicolor: 40,7 lm/W

Life Span/ Vida útil

L80 - 60.000h

Protection level/ Grado de Protección

IP68



- I0503 Broc STD projector for concrete pool
Proyector STD Broc para piscina de hormigón
- I0507 Broc STD projector for liner pool
Proyector STD Broc para piscina de liner
- I0504 Broc STD projector Wireless
Proyector Broc STD Wireless
- I0505 KIT 1 Broc STD + OnLED remote control
KIT 1 Broc STD + OnLED control remoto
- I0506 KIT 2 Broc STD + OnLED remote control
KIT 2 Broc STD + OnLED control remoto
- I0508 Broc STD projector for liner pool Wireless
Proyector STD Broc para piscina de liner Wireless
- I0509 KIT 1 Broc STD liner + OnLED remote control
KIT 1 Broc STD liner + OnLED control remoto
- I0510 KIT 2 Broc STD liner + OnLED remote control
KIT 2 Broc STD liner + OnLED control remoto

I0503 / I0504 / I0505 / I0506

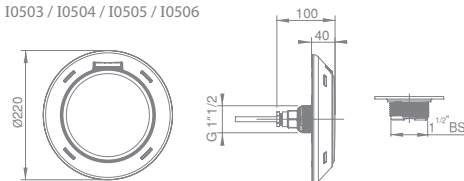

I0507 / I0508 / I0509 / I0510

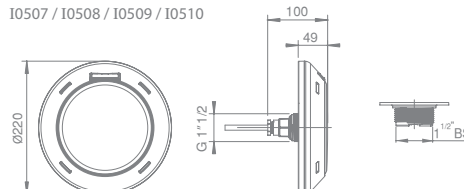

Code/ Código	Light/ Luz	Face Plate/ Embellecedor	Optic/ Óptica	Control/ Control
I0503	W Cool white Blanco frío	Material/ Material	N Narrow Concentrada	Multicolour Multicolor
I0507	WW Warm white Blanco cálido	P Plastic Plástico	M Medium Media	I0826 Modulator Modulador
	M Multicolour Multicolor	I Stainless Steel Acero Inox.	W Wide Abierta	I0828 Remote control Control Remoto
I0504M		Shape/ Forma		I0831 Push-button Pulsador
I0505M		S Square Cuadrado		DMX
I0506M		R Round Redondo		I0832DMX DMX power supply Alimentador DMX
I0508M				I0832DMXFE DMX external power supply Alimentador DMX fuente externa
I0509M				
I0510M				

PAR56 lamp OnLED V1

Lámpara PAR56 OnLED V1



We have developed the PAR56 lamp to achieve maximum power efficiency. Manufactured for use in swimming pools, in which a good, homogeneous distribution of light is required.

Lámpara PAR56, desarrollada para obtener la máxima eficiencia en consumo eléctrico. Fabricada para su utilización en piscinas, en las que es preciso una buena y homogénea distribución de la luz.

Consumption/ Consumo

Monocolour/ Monocolor: 16W (24VA)
Multicolour/ Multicolor: 27W (37VA)

Voltage/ Voltaje

12 Vac

Lumens/ Lúmenes

Monocolour/ Monocolor: 1.485 lm
Multicolour/ Multicolor: 1.100 lm

Efficiency/ Eficiencia

Monocolour/ Monocolor: 92,8 lm/W
Multicolour/ Multicolor: 40,7 lm/W

Life Span/ Vida útil

L80 - 60.000h

Protection level/ Grado de Protección

IP68



- I0002 PAR56 Lamp OnLED V1
Lámpara PAR56 OnLED V1
- I0006 Lamp OnLED Wireless
Lámpara OnLED Wireless
- I0007 KIT 1 lamp + OnLED remote control
KIT 1 lámpara + OnLED control remoto
- I0008 KIT 2 lamps + OnLED remote control
KIT 2 lámparas + OnLED control remoto

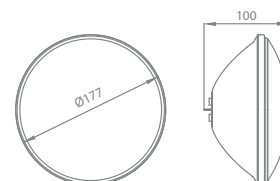

Code/ Código	Light/ Luz	Face Plate/ Embellecedor	Optic/ Óptica	Control/ Control
I0002	W Cool white Blanco frío WW Warm white Blanco cálido M Multicolour Multicolor	Material/ Material P Plastic Plástico I Stainless Steel Acero Inox.	N Narrow Concentrada M Medium Media W Wide Abierta	Multicolour Multicolor I0826 Modulator Modulador I0828 Remote control Control Remoto I0831 Push-button Pulsador DMX I0832DMX DMX power supply Alimentador DMX I0832DMXFE DMX external power supply Alimentador DMX fuente externa
I0006M I0007M I0008M		Shape/ Forma S Square Cuadrado R Round Redondo		

PAR56 lamp OnLED V2

Lámpara PAR56 OnLED V2



High performance underwater lamp. Thanks to its optic, the projection of light is maximised, making the most of its intensity and reducing light loss and light pollution to a minimum.

Lámpara subacuática de máximas prestaciones. Gracias a su óptica, optimiza la proyección de la luz aprovechando al máximo su intensidad y reduciendo al mínimo las pérdidas y la contaminación lumínica.

Consumption/ Consumo

Multicolour/ Multicolor: 48W (64VA)
Multicolour DMX/ Multicolor DMX: 48W (64VA)

Voltage/ Voltaje

12Vac

Lumens/ Lúmenes

Multicolour/ Multicolor: 2.544 lm
Multicolour DMX/ Multicolor DMX: 2.544 lm

Efficiency/ Eficiencia

Multicolour/ Multicolor: 53 lm/W
Multicolour DMX/ Multicolor DMX: 53 lm/W

Life Span/ Vida útil

L80 - 60.000h

Protection level/ Grado de Protección

IP68



I0003

PAR56 Lamp OnLED V2
Lámpara PAR56 OnLED V2

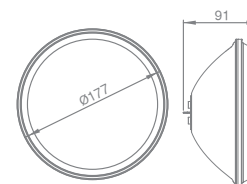

Code/ Código	Light/ Luz	Face Plate/ Embellecedor	Optic/ Óptica	Control/ Control
I0003	M Multicolour Multicolor MDMX Multicolour DMX Multicolor DMX	Material/ Material P Plastic Plástico I Stainless Steel Acero Inox.	N Narrow Concentrada M Medium Media W Wide Abierta	Multicolour Multicolor I0826 Modulator Modulador I0828 Remote control Control Remoto I0831 Push-button Pulsador DMX I0826DMX DMX Modulator Alimentador DMX I0832DMXFE DMX external power supply Alimentador DMX fuente externa
		Shape/ Forma S Square Cuadrado R Round Redondo		

PAR56 DC lamp OnLED V1

Lámpara PAR56 DC OnLED V1



High efficiency PAR56, high quality lighting due to the design lens. Power consumption 14W. Power supply included.

Lámpara PAR56 DC de alta eficiencia, con una iluminación de calidad por el diseño de la lente. Consumo energético de 14W. Incluye Fuente de alimentación.

Consumption/ Consumo

14W (14VA)

Voltage/ Voltaje

24 Vdc

Lumens/ Lúmenes

1.485 lm

Efficiency/ Eficiencia

106 lm/W

Life Span/ Vida útil

L80 - 60.000h

Protection level/ Grado de Protección

IP68



I0009 PAR56 DC Lamp OnLED V1
Lámpara PAR56 DC OnLED V1

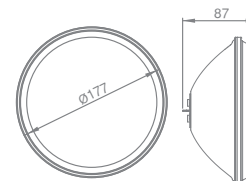

Code/ Código	Light/ Luz	Face Plate/ Embellecedor	Optic/ Óptica	Control/ Control
I0009	W Cool white Blanco frío WW Warm white Blanco cálido	Material/ Material P Plastic Plástico I Stainless Steel Acero Inox.	N Narrow Concentrada M Medium Media W Wide Abierta	Multicolour Multicolor I0826 Modulator Modulador I0828 Remote control Control Remoto I0831 Push-button Pulsador DMX I0832DMX DMX power supply Alimentador DMX I0832DMXFE DMX external power supply Alimentador DMX fuente externa
		Shape/ Forma S Square Cuadrado R Round Redondo		

PAR56 DC lamp OnLED V2

Lámpara PAR56 DC OnLED V2



High efficiency PAR56, high quality lighting due to the design lens. Power consumption 32W and 4320 lumens. Power supply included.

Lámpara PAR56 DC de alta eficiencia, con una iluminación de alta calidad por el diseño de la lente. Consumo energético de 32W y 4300 lúmenes. Incluye Fuente de alimentación.

Consumption/ Consumo

32W (32VA)

Voltage/ Voltaje

24 Vdc

Lumens/ Lúmenes

4.320 lm

Efficiency/ Eficiencia

135 lm/W

Life Span/ Vida útil

L80 - 60.000h

Protection level/ Grado de Protección

IP68



I0010 PAR56 DC Lamp OnLED V2
Lámpara PAR56 DC OnLED V2

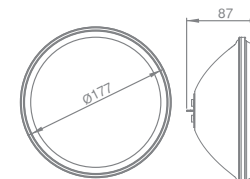

Code/ Código	Light/ Luz	Face Plate/ Embellecedor	Optic/ Óptica	Control/ Control
I0010	W Cool white Blanco frío WW Warm white Blanco cálido	Material/ Material P Plastic Plástico I Stainless Steel Acero Inox. Shape/ Forma S Square Cuadrado R Round Redondo	N Narrow Concentrada M Medium Media W Wide Abierta	Multicolour Multicolor I0826 Modulator Modulador I0828 Remote control Control Remoto I0831 Push-button Pulsador DMX I0832DMX DMX power supply Alimentador DMX I0832DMXFE DMX external power supply Alimentador DMX fuente externa

STD projector OnLED V1

Proyector STD OnLED V1



This projector includes everything necessary for its installation in all kinds of swimming pools. It consumes 50 - 65% less than the STD projector OnLED V2. It is suitable to illuminate residential swimming pools or installations that do not require a great quantity of light.

Proyector que incorpora todo lo necesario para su instalación en piscinas de cualquier tipo. Consume entre 50 - 65% menos que el proyector STD OnLED V2. Ideal para iluminar piscinas residenciales o instalaciones que no precisen de una gran cantidad de luz.

Consumption/ Consumo

Monocolour/ Monocolor: 16W (24VA)
Multicolour/ Multicolor: 27W (37VA)

Voltage/ Voltaje

12 Vac

Lumens/ Lúmenes

Monocolour/ Monocolor: 1.485 lm
Multicolour/ Multicolor: 1.100 lm

Efficiency/ Eficiencia

Monocolour/ Monocolor: 92,81 lm/W
Multicolour/ Multicolor: 40,7 lm/W

Life Span/ Vida útil

L80 - 60.000h

Protection level/ Grado de Protección

IP68



- I0101 Light spot STD V1
Punto de luz STD V1
- I0102 STD projector V1 concrete pool
Proyector STD V1 piscina de hormigón
- I0103 STD projector V1 prefabricated pool
Proyector STD V1 piscina prefabricada
- I0104 STD V1 projector prefabricated pool model Parker
Proyector STD V1 piscina prefabricada modelo Parker
- I0113 KIT 1 RGB W. spot light + OnLED remote control
KIT 1 punto de luz RGB W.+ OnLED control remoto
- I0114 KIT 2 RGB W. spot light + OnLED remote control
KIT 2 puntos de luz RGB W. + OnLED control remoto
- I0115 RGB Wireless spot light
Punto de luz RGB Wireless

I0101 / I0113 / I0114 / I0115

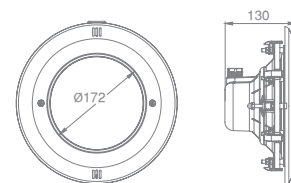

I0102 / I0103 / I0104

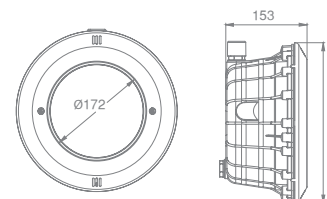

Code/ Código	Light/ Luz	Face Plate/ Embellecedor	Optic/ Óptica	Control/ Control
I0101	NW Neutral white Blanco neutro	Material/ Material	N Narrow Concentrada	Multicolour Multicolor
I0102	W Cool white Blanco frío	P Plastic Plástico	M Medium Media	I0826 Modulator Modulador
I0103	WW Warm white Blanco cálido	I Stainless Steel Acero Inox.	W Wide Abierta	I0828 Remote control Control Remoto
I0104	M Multicolour Multicolor	Shape/ Forma		I0831 Push-button Pulsador
I0113M		S Square Cuadrado		DMX
I0114M		R Round Redondo		I0832DMX DMX power supply Alimentador DMX
I0115M				I0832DMXFE DMX external power supply Alimentador DMX fuente externa

STD projector OnLED V2

Proyector STD OnLED V2



This projector provides greater light and intensity for your project; and also greater power efficiency and reduced light pollution due to its new optic, which maximises light projection and reduces light loss.

El proyector STD OnLED V2 aporta más luminosidad y más intensidad a su proyecto; también una mayor eficiencia energética y una menor contaminación luminosa debido a su nueva óptica, que optimiza la proyección y disminuye las pérdidas de luz.

Consumption/ Consumo

Multicolour/ Multicolor: 48W (64VA)
MDMX/ MDMX: 48W (64VA)

Voltage/ Voltaje

12Vac

Lumens/ Lúmenes

Multicolour/ Multicolor: 2.544 lm
MDMX/ MDMX: 2.544 lm

Efficiency/ Eficiencia

Multicolour/ Multicolor: 53 lm/W
MDMX/ MDMX: 53 lm/W

Life Span/ Vida útil

L80 - 60.000h

Protection level/ Grado de Protección

IP68



- I0107 Light spot STD V2
Punto de luz STD V2
- I0108 STD projector V2 concrete pool
Proyector STD V2 piscina de hormigón
- I0109 STD projector V2 prefabricated pool
Proyector STD V2 piscina prefabricada
- I0110 STD V2 projector prefabricated pool model Parker
Proyector STD V2 piscina prefabricada modelo Parker

I0107

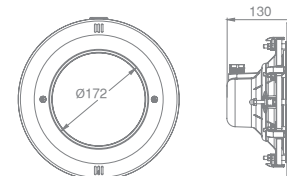

I0108 / I0109 / I0110

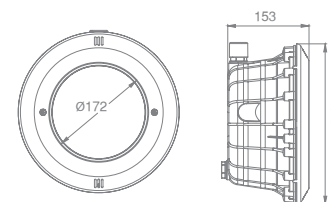

Code/ Código	Light/ Luz	Face Plate/ Embellecedor	Optic/ Óptica	Control/ Control
I0107	M Multicolour Multicolor	Material/ Material	N Narrow Concentrada	Multicolour Multicolor
I0108	MDMX Multicolour DMX Multicolor DMX	P Plastic Plástico	M Medium Media	I0826 Modulator Modulador
I0109		I Stainless Steel Acero Inox.	W Wide Abierta	I0828 Remote control Control Remoto
I0110		Shape/ Forma		I0831 Push-button Pulsador
		S Square Cuadrado		DMX
		R Round Redondo		I0826DMX DMX Modulator Alimentador DMX
				I0832DMXFE DMX external power supply Alimentador DMX fuente externa

STD DC projector OnLED V1

Proyector STD DC OnLED V1



High efficiency projector and quality lighting due to lens. Power consumption 14W. Power supply included.

Proyector de alta eficiencia con una iluminación de calidad por el diseño de la lente. Consumo energético de 14W. Incluye Fuente de alimentación.

Consumption/ Consumo

14W (14VA)

Voltage/ Voltaje

24 Vdc

Lumens/ Lúmenes

1.485 lm

Efficiency/ Eficiencia

106 lm/W

Life Span/ Vida útil

L80 - 60.000h

Protection level/ Grado de Protección

IP68



- I0116 Light spot STD DC V1
Punto de luz STD DC V1
- I0118 Light spot STD DC V1 (global)
Punto de luz STD DC V1 (global)
- I0120 STD DC projector V1 concrete pool
Proyector STD DC V1 piscina hormigón
- I0121 STD DC projector V1 prefabricated pool
Proyector STD DC V1 piscina prefabricada

I0116 / I0118

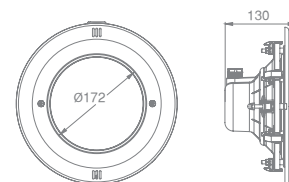

I0120 / I0121

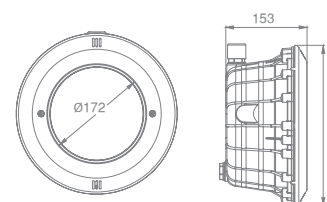

Code/ Código	Light/ Luz	Face Plate/ Embellecedor	Optic/ Óptica	Control/ Control
I0116	W Cool white Blanco frío	Material/ Material	N Narrow Concentrada	Multicolour Multicolor
I0118	WW Warm white Blanco cálido	P Plastic Plástico	M Medium Media	I0826 Modulator Modulador
I0120		I Stainless Steel Acero Inox.	W Wide Abierta	I0828 Remote control Control Remoto
I0121		Shape/ Forma		I0831 Push-button Pulsador
		S Square Cuadrado		DMX
		R Round Redondo		I0832DMX DMX power supply Alimentador DMX
				I0832DMXFE DMX external power supply Alimentador DMX fuente externa

STD DC projector OnLED V2

Proyector STD DC OnLED V2



High efficiency projector with high quality lighting due to the design lens. Power consumption 32W and 4320 lumens. Power supply included.

Proyector de alta eficiencia con una iluminación de alta calidad por el diseño de la lente. Consumo energético de 32W y 4300 lúmenes. Incluye Fuente de alimentación.

Consumption/ Consumo

32W (32VA)

Voltage/ Voltaje

24 Vdc

Lumens/ Lúmenes

4.320 lm

Efficiency/ Eficiencia

135 lm/W

Life Span/ Vida útil

L80 - 60.000h

Protection level/ Grado de Protección

IP68



- I0117 Light spot STD DC V2
Punto de luz STD DC V2
- I0119 Light spot STD DC V2 (global)
Punto de luz STD DC V2 (global)
- I0124 STD DC projector V2 concrete pool
Proyector STD DC V2 piscina hormigón
- I0125 STD DC projector V2 prefabricated pool
Proyector STD DC V2 piscina prefabricada

I0117 / I0119

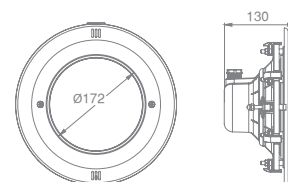

I0124 / I0125

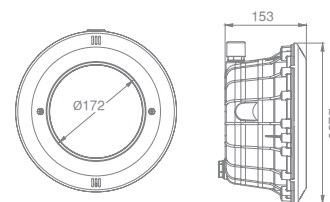

Code/ Código	Light/ Luz	Face Plate/ Embellecedor	Optic/ Óptica	Control/ Control
I0117	W Cool white Blanco frío	Material/ Material	N Narrow Concentrada	Multicolour Multicolor
I0119	WW Warm white Blanco cálido	P Plastic Plástico	M Medium Media	I0826 Modulator Modulador
I0124		I Stainless Steel Acero Inox.	W Wide Abierta	I0828 Remote control Control Remoto
I0125		Shape/ Forma		I0831 Push-button Pulsador
		S Square Cuadrado		DMX
		R Round Redondo		I0832DMX DMX power supply Alimentador DMX
				I0832DMXFE DMX external power supply Alimentador DMX fuente externa

Underwater lighting | iluminación subacuática



STD stainless steel projector OnLED V1

Proyector STD OnLED V1 acero inoxidable



Manufactured entirely in AISI 316 steel which provides high added value for aquatic projects. It is suitable to illuminate residential swimming pools or installations that do not require a great quantity of light.

Fabricado íntegramente en acero AISI 316 que le aporta un alto valor añadido para proyectos acuáticos. Ideal para iluminar piscinas residenciales o instalaciones que no precisen de una gran cantidad de luz.

Consumption/ Consumo

Monocolour/ Monocolor: 16W (24VA)
Multicolour/ Multicolor: 27W (37VA)

Voltage/ Voltaje

12 Vac

Lumens/ Lúmenes

Monocolour/ Monocolor: 1.485 lm
Multicolour/ Multicolor: 1.100 lm

Efficiency/ Eficiencia

Monocolour/ Monocolor: 92,8 lm/W
Multicolour/ Multicolor: 40,7 lm/W

Life Span/ Vida útil

L80 - 60.000h

Protection level/ Grado de Protección

IP68



- I0105 STD stainless steel projector V1 concrete pool
Proyector STD V1 acero inoxidable piscina de hormigón
- I0106 STD stainless steel projector V1 prefabricated pool
Proyector STD V1 acero inoxidable piscina prefabricada

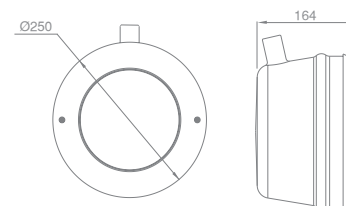

Code/ Código	Light/ Luz	Face Plate/ Embellecedor	Optic/ Óptica	Control/ Control
I0105	W Cool white Blanco frío	Material/ Material	N Narrow Concentrada	Multicolour Multicolor
I0106	WW Warm white Blanco cálido	P Plastic Plástico	M Medium Media	I0826 Modulator Modulador
	M Multicolour Multicolor	I Stainless Steel Acero Inox.	W Wide Abierta	I0828 Remote control Control Remoto
		Shape/ Forma		I0831 Push-button Pulsador
		S Square Cuadrado		DMX
		R Round Redondo		I0832DMX DMX power supply Alimentador DMX
				I0832DMXFE DMX external power supply Alimentador DMX fuente externa

Flat projector OnLED V1

Proyector plano OnLED V1

Projector suitable for concrete and prefabricated pools.

Due to its easy installation, this light is ideal for existing constructions. And as there is no niche, no building work is required for its installation, which is done by fixing a support to the wall holding the projector.

Proyector apto para piscinas de hormigón y prefabricadas.

Es una luminaria ideal para construcciones existentes, ya que es de muy fácil instalación. Al no llevar nicho no necesita de obras para su instalación. Ésta se realiza a partir de un soporte que se fija en la pared y sustenta el proyector.

Consumption/ Consumo

Monocolour/ Monocolor: 14,5W (20VA)

Multicolour/ Multicolor: 22W (29VA)

Voltage/ Voltaje

12 Vac

Lumens/ Lúmenes

Monocolour/ Monocolor: 1.485 lm

Multicolour/ Multicolor: 1.100 lm

Efficiency/ Eficiencia

Monocolour/ Monocolor: 102,4 lm/W

Multicolour/ Multicolor: 50 lm/W

Life Span/ Vida útil

L80 - 60.000h

Protection level/ Grado de Protección

IP68



- I0220 Flat projector V1
Proyector plano V1 piscina
- I0222 KIT 1flat projector + Remote control
KIT 1proyector plano + Control r.
- I0224 KIT 2 flat projectors + Remote control
KIT 2 proyectores planos + Control r.
- I0223 Flat projector Wireless
Proyector plano Wireless

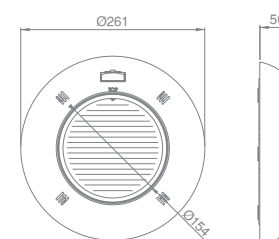

Code/ Código	Light/ Luz	Face Plate/ Embellecedor	Optic/ Óptica	Control/ Control
I0220	W Cool white Blanco frío	Material/ Material	N Narrow Concentrada	Multicolour Multicolor
I0222	WW Warm white Blanco cálido	P Plastic Plástico	M Medium Media	I0826 Modulator Modulador
I0223	M Multicolour Multicolor	I Stainless Steel Acero Inox.	W Wide Abierta	I0828 Remote control Control Remoto
I0224		Shape/ Forma		I0831 Push-button Pulsador
		S Square Cuadrado		DMX
		R Round Redondo		I0832DMX DMX power supply Alimentador DMX
				I0832DMXFE DMX external power supply Alimentador DMX fuente externa

Flat projector OnLED V2

Proyector plano OnLED V2



Projector suitable for any type of pool (concrete, liner, panels, etc.)

Due to its easy installation, this light is ideal for existing constructions. And as there is no niche, no building work is required for its installation, which is done by fixing a support to the wall holding the projector.

Proyector apto para cualquier tipo de piscinas (hormigón, liner, paneles, etc.)

Es una luminaria ideal para construcciones existentes, ya que es de muy fácil instalación. Al no llevar nicho no necesita de obras para su instalación. Ésta se realiza a partir de un soporte que se fija en la pared y sustenta el proyector.

Consumption/ Consumo

Monocolour/ Monocolor: 58W (60VA)

Multicolour/ Multicolor: 48W (64VA)

MDMX/ MDMX: 48W (64VA)

Voltage/ Voltaje

12Vac

Lumens/ Lúmenes

Monocolour/ Monocolor: 4.320 lm

Multicolour/ Multicolor: 2.544 lm

MDMX/ MDMX: 2.544 lm

Efficiency/ Eficiencia

Monocolour/ Monocolor: 74,4 lm/W

Multicolour/ Multicolor: 53 lm/W

MDMX/ MDMX: 53 lm/W

Life Span/ Vida útil

L80 - 60.000h

Protection level/ Grado de Protección

IP68



I0206 Flat projector V2 concrete pool
Proyector plano V2 piscina de hormigón

I0207 Flat projector V2 prefabricated pool
Proyector plano V2 piscina prefabricada

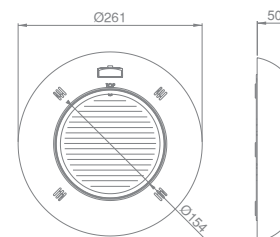

Code/ Código	Light/ Luz	Face Plate/ Embellecedor	Optic/ Óptica	Control/ Control
I0206	W Cool white Blanco frío	Material/ Material	N Narrow Concentrada	Multicolour Multicolor
I0207	WW Warm white Blanco cálido	P Plastic Plástico	M Medium Media	I0826 Modulator Modulador
	M Multicolour Multicolor	I Stainless Steel Acero Inox.	W Wide Abierta	I0828 Remote control Control Remoto
	MDMX Multicolour DMX Multicolor DMX	Shape/ Forma		I0831 Push-button Pulsador
		S Square Cuadrado		DMX
		R Round Redondo		I0826DMX DMX Modulator Alimentador DMX
				I0832DMXFE DMX external power supply Alimentador DMX fuente externa



Sports facilities
Instalaciones Deportivas

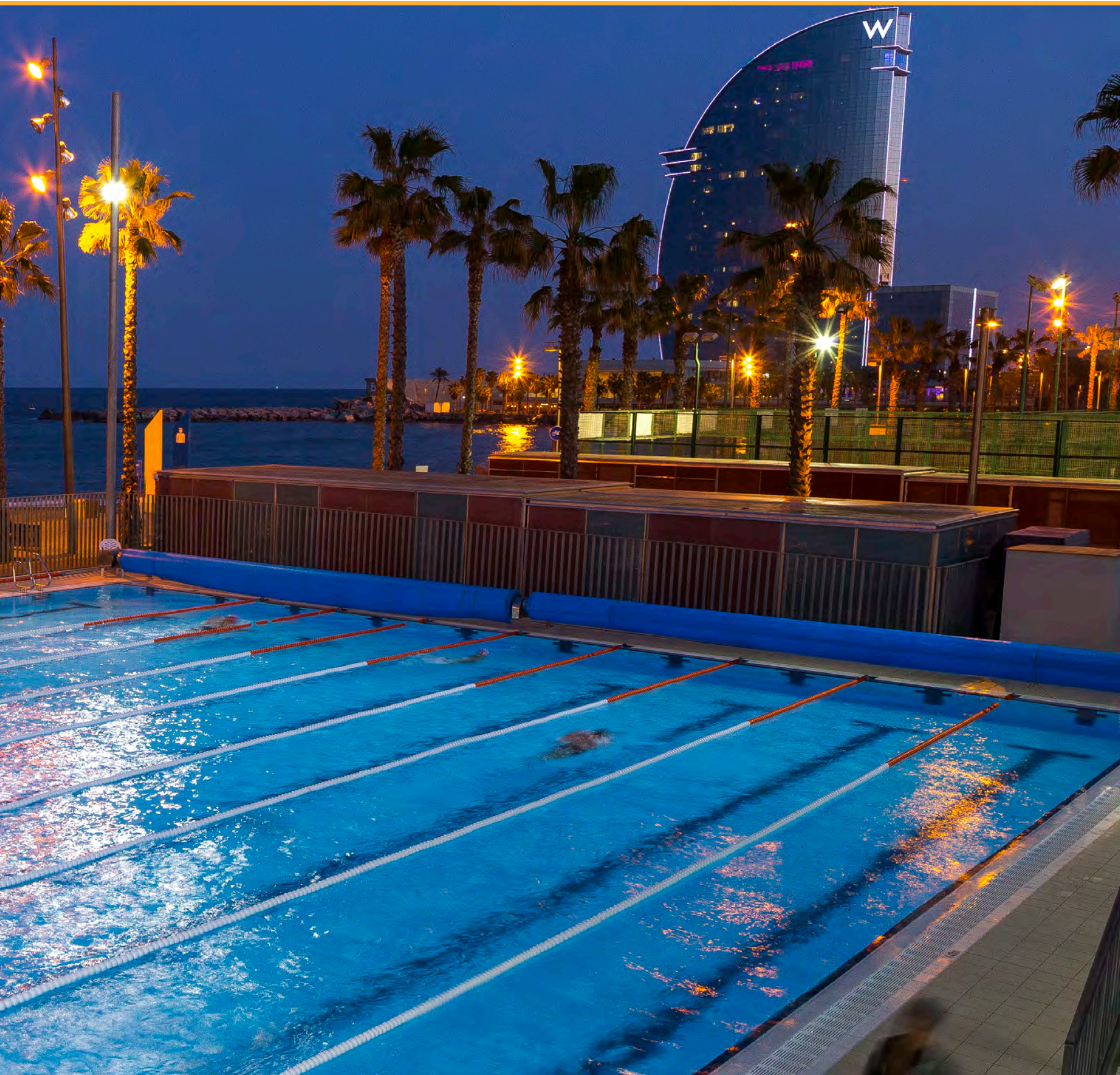

XTelia S



A high-performance flood light that covers the most stringent lighting requirements.

High luminous flux, high efficiency and IP66 rating, suitable for installation in sports facilities.

Proyector de altas prestaciones lumínicas para cubrir las necesidades de iluminación más exigentes.

Elevado flujo luminoso, alta eficiencia lumínica y alto grado de protección IP66, ideal para instalar en instalaciones deportivas.

Consumption / Consumo

100 W - 75W - 50W

Voltage / Voltaje

220 - 240 Vac

Frequency / Frecuencia

50 / 60 Hz

Protection level / Grado de Protección

IP66 - IK08

Weight / Peso

5,8 Kg

UHF / FHS

< 1%

Life Span / Vida útil

L80 - 50.000h



I3030 XTelia S

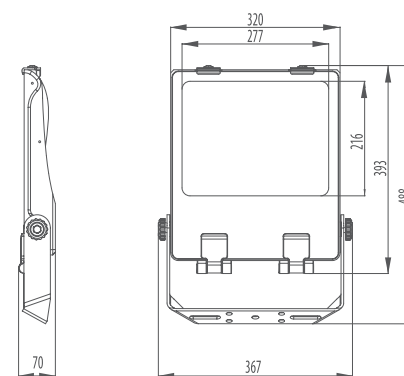

Photometry BM

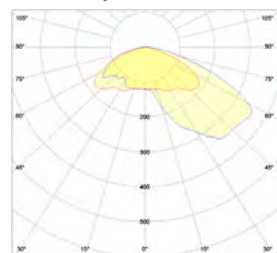

H 13.900lm L 10.450lm S 6.950lm

Photometry SN

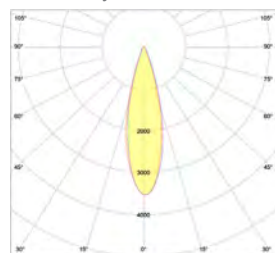

H 15.000lm L 11.250lm S 7.500lm

Photometry SM

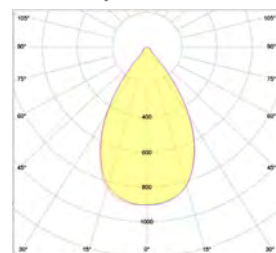

H 15.700lm L 11.800lm S 7.850lm

Photometry SWM

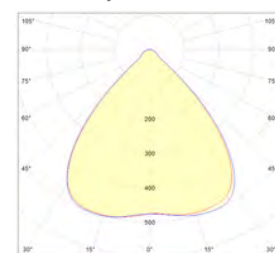

H 15.800 lm L 11.850lm S 7.900lm

Code / Código

Light / Luz

Power / Potencia

Photometry / Fotometrías

Option / Opción

I3030

NW Neutral white | Blanco neutro
WW Warm white | Blanco cálido

H 100W
L 75W
S 50W

Pattern / Patrón
B Asymmetric | Asimétrica
S Symmetric | Simétrica

Optic / Óptica
M Medium
N Narrow

E DALI Control | Control DALI
G 1-10 | 1-10

XTelia M



A high-performance flood light that covers the most stringent lighting requirements.

High luminous flux, high efficiency and IP66 rating, suitable for installation in sports facilities.

Proyector de altas prestaciones lumínicas para cubrir las necesidades de iluminación más exigentes.

Elevado flujo luminoso, alta eficiencia lumínica y alto grado de protección IP66, ideal para instalar en instalaciones deportivas.

Consumption / Consumo

150W - 200W

Voltage / Voltaje

220 - 240 Vac

Frequency / Frecuencia

50 / 60 Hz

Protection level / Grado de Protección

IP66 - IK08

Weight / Peso

6,7 Kg

UHF / FHS

< 1%

Life Span / Vida útil

L80 - 50.000h



I3031 XTelia M

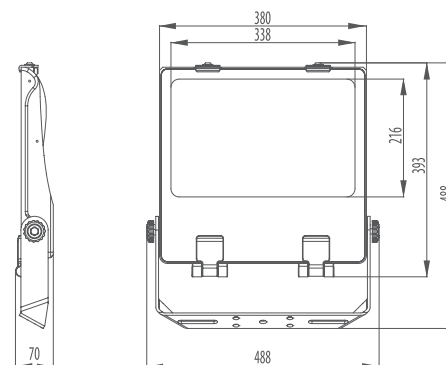

Photometry BM

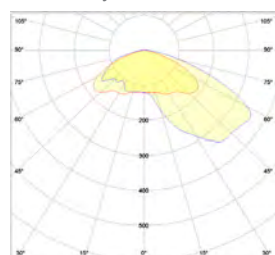

L 20.100lm H 26.800lm

Photometry SN

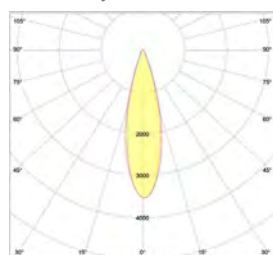

L 21.500lm H 28.650lm

Photometry SM

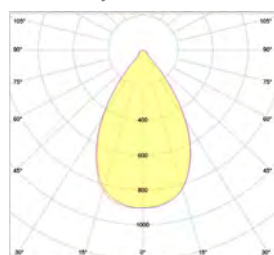

L 22.250lm H 29.650lm

Photometry SWM

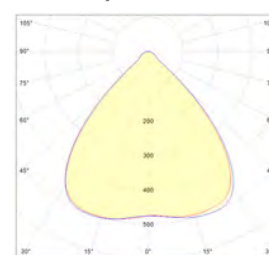

L 22.500lm H 30.000lm

Code / Código

Light / Luz

Power / Potencia

Photometry / Fotometrías

Option / Opción

I3031

NW Neutral white | Blanco neutro
WW Warm white | Blanco cálido

L 150W
H 200W

Pattern / Patrón
B Asymmetric | Asimétrica
S Symmetric | Simétrica

Optic / Óptica
M Medium
N Narrow
WM Wide Medium

E DALI Control | Control DALI
G 1-10 | 1-10



XTelia L



A high-performance flood light that covers the most stringent lighting requirements.

High luminous flux, high efficiency and IP66 rating, suitable for installation in sports facilities.

Proyector de altas prestaciones lumínicas para cubrir las necesidades de iluminación más exigentes.

Elevado flujo luminoso, alta eficiencia lumínica y alto grado de protección IP66, ideal para instalar en instalaciones deportivas.

Consumption / Consumo

250W - 300W

Voltage / Voltaje

220 - 240 Vac

Frequency / Frecuencia

50 / 60 Hz

Protection level / Grado de Protección

IP66 - IK08

Weight / Peso

9,3 Kg

UHF / FHS

< 1%

Life Span / Vida útil

L80 - 50.000h



I3032 XTelia L

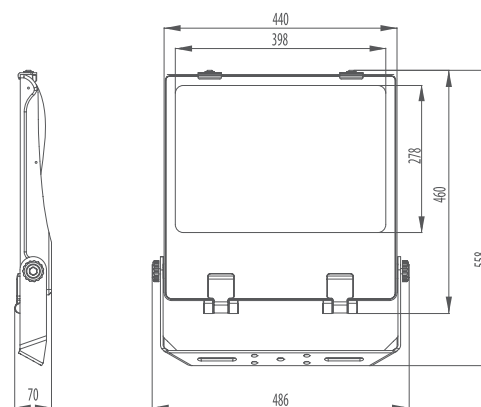

Photometry BM

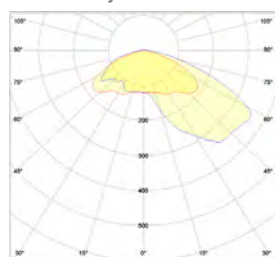

L 35.300lm H 42.350lm

Photometry SN

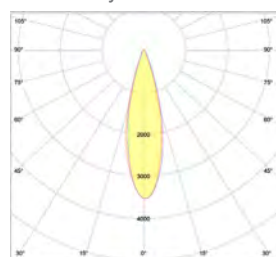

L 37.650lm H 45.150lm

Photometry SM

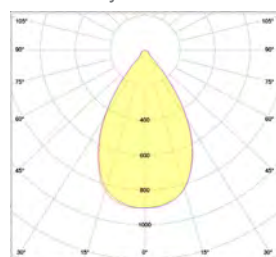

L 39.800lm H 47.750lm

Photometry SWM

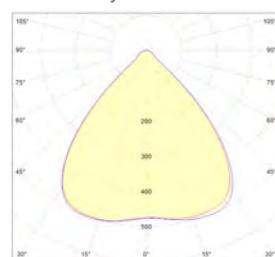

L 38.950lm H 46.750lm

Code / Código

Light / Luz

Power / Potencia

Photometry / Fotometrías

Option / Opción

I3032

NW Neutral white | Blanco neutro
WW Warm white | Blanco cálido

L 250W
H 300W

Pattern / Patrón
B Asymmetric | Asimétrica
S Symmetric | Simétrica

Optic / Óptica
M Medium
N Narrow
WM Wide Medium

E DALI Control | Control DALI
G 1-10 | 1-10



Architectural lighting
Iluminación arquitectónica



Adjustable linear projector Proyector lineal orientable



Adjustable 13 W linear projector for both indoor and outdoor areas. Made from aluminum and white DMX, this multicolour projector is perfect for wall washing.

Proyector lineal orientable de 13W apto para ser instalado en zonas de interior como exterior. Fabricado en aluminio, multicolor y blanco DMX perfecto para hacer baños de pared.

Consumption/ Consumo

I1279: 13W | I1280: 26W | I1281: 52W

Voltage/ Voltaje

24 Vdc

Lumens/ Lúmenes

I1279: 900lm | I1280: 1.800lm | I1281: 3.600lm

Efficiency/ Eficiencia

69,23 lm/W

Life Span/ Vida útil

L80 - 60.000h

Protection level/ Grado de Protección

IP65



I1279 Linear adjustable projector 25cm.
Proyector lineal orientable 25cm.

I1280 Linear adjustable projector 50cm.
Proyector lineal orientable 50cm.

I1281 Linear adjustable projector 100cm.
Proyector lineal orientable 100cm.

I1279

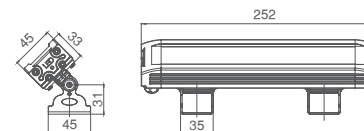

I1280

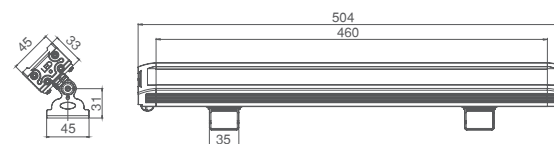

I1281

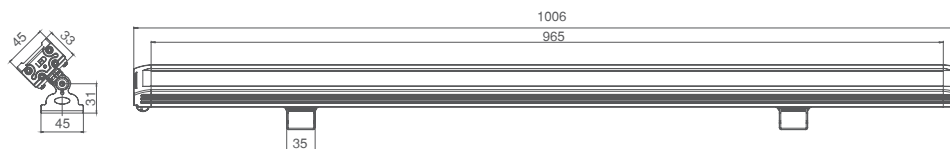

Code/ Código	Light/ Luz	Face Plate/ Embellecedor	Optic/ Óptica	Control/ Control
I1279	W Cool white Blanco frío	Material/ Material	N Narrow Concentrada	Multicolour Multicolor
I1280	WW Warm white Blanco cálido	P Plastic Plástico	M Medium Media	I0826 Modulator Modulador
I1281	MWDMX Multicolour White DMX Multicolor Blanco DMX	I Stainless Steel Acero Inox.	W Wide Abierta	I0828 Remote control Control Remoto I0831 Push-button Pulsador DMX I0832DMX DMX power supply Alimentador DMX I0832DMXFE DMX external power supply Alimentador DMX fuente externa
		Shape/ Forma		
		S Square Cuadrado		
		R Round Redondo		



Mini recessed projector

Proyectores Mini enrasado

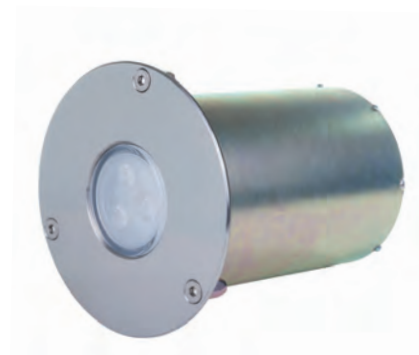

These projectors are conceived for installing on swimming pools or water spaces. Its glass lens and AISI 316 stainless steel trim are designed to 500 Kgr. static force.

Estos proyectores están concebidos para instalarse en piscinas o espacios acuáticos.

Su lente de vidrio y embellecedor de acero inoxidable AISI 316 estan diseñados para aguantar 500 Kgr. de carga estática.

Consumption/ Consumo	Mini	Mini +
Monocolour/ Monocolor:	4W (6VA)	6W (9VA)
Multicolour/ Multicolor:	4W (7VA)	6W (9VA)
MDMX/ MDMX:	4W (4VA)	6W (6VA)
MWDMX/ MWDMX:	5W (5VA)	8W (8VA)

Voltage/ Voltaje

Monocolour/ Monocolor:	12 Vac	12 Vac
Multicolour/ Multicolor:	12 Vac	12 Vac
MDMX/ MDMX:	24 Vdc	24 Vdc
MWDMX/ MWDMX:	24 Vdc	24 Vdc

Lumens/ Lúmenes

Monocolour/ Monocolor:	315 lm	550 lm
Multicolour/ Multicolor:	186 lm	330 lm
MDMX/ MDMX:	186 lm	330 lm
MWDMX/ MWDMX:	300 lm	430 lm

Efficiency/ Eficiencia

Monocolour/ Monocolor:	78,7 lm/W	91,66 lm/W
Multicolour/ Multicolor:	46,5 lm/W	55 lm/W
MDMX/ MDMX:	46,5 lm/W	55 lm/W
MWDMX/ MWDMX:	60 lm/W	53,75 lm/W

Life Span/ Vida útil

L80 - 60.000h

Protection level/ Grado de Protección

IP68 -IK10

I1226	I1282	I1285	I1286

- I 1226 Mini recessed projector (galvanized niche)
Proyector Mini enrasado (nicho galvanizado)
- I 1282 Mini+ recessed projector (galvanized niche)
Proyector Mini + enrasado (nicho galvanizado)
- I 1285 Mini recessed projector (inox niche)
Proyector Mini enrasado (nicho inox)
- I 1286 Mini+ recessed projector (inox niche)
Proyector Mini + enrasado (nicho inox)

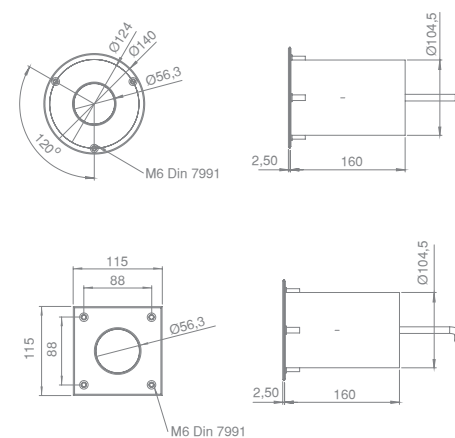

Code/ Código	Light/ Luz	Face Plate/ Embellecedor	Optic/ Óptica	Control/ Control
I 1226	W Cool white Blanco frío	Material/ Material	N Narrow Concentrada	Multicolour Multicolor
I 1282	WW Warm white Blanco cálido	P Plastic Plástico	M Medium Media	I0826 Modulator Modulador
I 1285	M Multicolour Multicolor	I Stainless Steel Acero Inox.	W Wide Abierta	I0828 Remote control Control Remoto
I 1286	MDMX Multicolour DMX Multicolor DMX	Shape/ Forma		I0831 Push-button Pulsador
	MWDMX Multicolour White DMX Multicolor Blanco DMX	S Square Cuadrado		DMX
		R Round Redondo		I0832DMX DMX power supply Alimentador DMX
				I0832DMXFE DMX external power supply Alimentador DMX fuente externa

Control devices
Dispositivos de control



DMX OnLED power supply Alimentador OnLED DMX

This power pack can handle up to 9 projectors separately (27 DMX channels) or grouped together (3 DMX channels). It can be directly plugged into a 230 V AC power supply. Internal 60 W power adapter included.

El alimentador puede gobernar hasta 9 proyectores de forma independiente (27 canales DMX) o conjunta (3 canales DMX). Se conecta directamente a la red de 230 V AC. Fuente interna de 60W incluida.



I0832DMX DMX OnLED power supply
Alimentador OnLED DMX

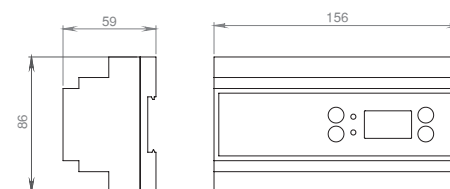

DMX OnLED external power supply Alimentador OnLED DMX fuente externa

This power pack is able to independently control 9 RGB DMX addresses (27 channels) or 6 RGBW DMX addresses (24 channels). External power supply required.

El alimentador puede gobernar hasta 9 direcciones RGB DMX (27 canales) o bien 6 direcciones RGBW DMX (24 canales) de forma independiente. Necesita fuente externa.



I0832DMXFE DMX OnLED external power supply
Alimentador OnLED DMX fuente externa

I0900 X-LED/ T-LED MWDMM external power supply
Alimentador X-LED/ T-LED MWDMM fuente externa

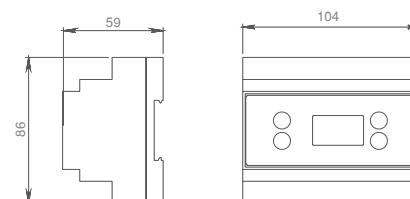

OnLED DMX modulator Modulador OnLED DMX

For the installations of PAR56 DMX bulbs or projectors / DMX Flat projectors in pools it is necessary to incorporate the DMX OnLED modulator between the DMX interface and the projectors.

One DMX Modulator should be used for each group of DMX projectors connected to the same safety pool transformer.

Para la instalación de lámparas o proyectores PAR56 DMX / proyectores Planos DMX en piscinas es necesario incorporar el Modulador OnLED DMX entre la Interfaz DMX y los proyectores.

Se debe utilizar un Modulador por cada grupo de proyectores DMX conectados a un mismo transformador de seguridad.



I0826DMX DMX OnLED modulator
Modulador OnLED DMX

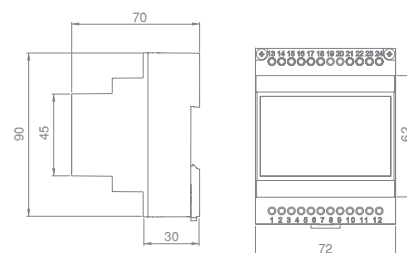

OnDMX Touchscreen

Pantalla tàctil OnDMX

OnDMX Touchscreen is designed to provide an easy control solution to any project. The DMX controller integrates a touch sensitive panel, including a color wheel, to easily select features such as dimming, colour changing, light scenes or colour changing speed.

All features can also be programmed by a PC.

La Pantalla tàctil OnDMX està dissenyada per dar una solució de control fàcil a qualsevol projecte. El controlador DMX integra un panel sensible al tacto, que inclou una roda de color, per seleccionar fàcilment funcions com regulació de intensitat, canvi de color, escenes de llum o velocitat del canvi de color. Totes les funcions també se poden programar a través d'un PC.



I 0905

OnDMX Touchscreen
(Controlador + Software + Manual + Fuente alimentación)
Pantalla tàctil OnDMX
(Controller + Software + Manual + Power supply)

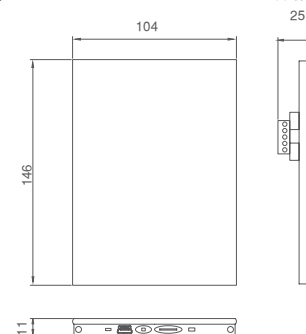

OnDMX Pro Touchscreen

Pantalla tàctil OnDMX Pro

OnDMX Touchscreen Pro is designed to provide an easy control solution to the most demanding light projects. The DMX controller integrates a touch sensitive panel, including a color wheel, to easily select features such as dimming, colour changing, light scenes, light zones or colour changing speed. All features can also be programmed by a PC or smartphone.

La Pantalla tàctil OnDMX Pro està dissenyada per dar una solució de control fàcil a els projectes més exigents. El controlador DMX integra un panel sensible al tacto, que inclou una roda de color, per seleccionar fàcilment funcions com regulació de intensitat, canvi de color, escenes de llum, zones de llum o velocitat del canvi de color. Totes les funcions també se poden programar a través d'un PC o telèfon mòbil.

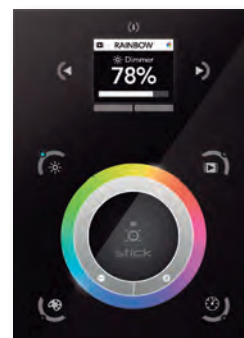

I 0906

OnDMX Pro Touchscreen
(Controlador + Software + Manual + Fuente alimentación)
Pantalla tàctil OnDMX Pro
(Controller + Software + Manual + Power supply)

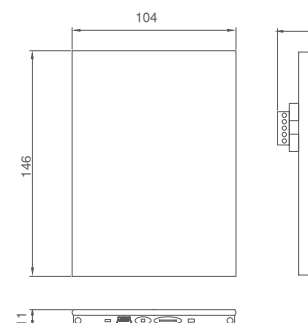

N/C Pushbutton Pulsador N/C

Basic OnLED System. With each press it will change colour or sequence. It's a N/C push-button. With it will have the possibility of changing between 7 colours and 7 different colour changing programmes.

Sistema Basic OnLED. Con cada pulsación se cambiará el color o la secuencia. Se trata de un pulsador N/C. Con él tendrá la posibilidad de cambio entre 7 colores y 7 secuencias de cambio de color diferentes.



I0831 N/C Pushbutton/
Pulsador N/C

OnLED modulator Modulador OnLED

Total OnLED system. It is able to switch the multicolor projectors On and Off, change their colors and set the time for putting the projectors in sleep mode.

Sistema Total OnLED. Se controla el encendido y apagado de los proyectores multicolor, cambio de color y programa y temporizador del apagado.



I0826 OnLED modulator
Modulador OnLED

I0827 OnLED modulator 110V
Modulador OnLED 110V

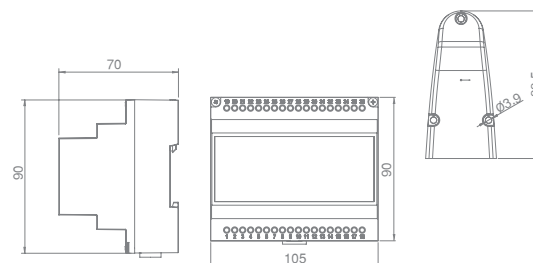

OnLED remote control

Control remoto OnLED



System that complements the Total OnLED system, of the Modulator.

With it you will be able to control the following actions:

- Switching the lamps on and off
- Changing colour
- Changing colour sequence
- Speed of colour sequence
- Switching off function (sleep)

Sistema que complementa el sistema Total OnLED, del Modulador.

Con él podrá controlar las siguientes acciones:

- Encendido y apagado de los proyectores.
- Cambio de color.
- Cambio de secuencia de colores.
- Velocidad de la secuencia de colores.
- Función de apagado (sleep).

I0828

OnLED remote control
Control remoto OnLED

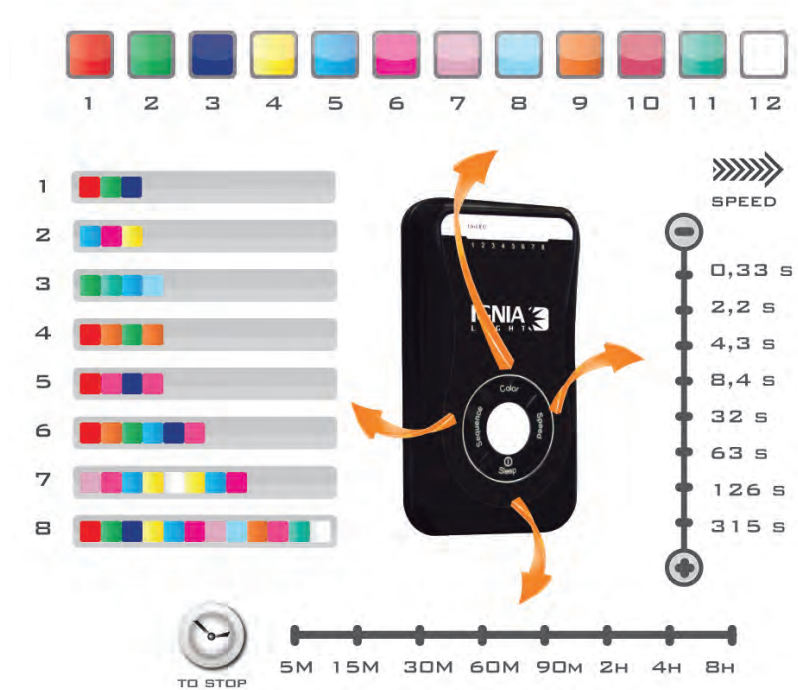
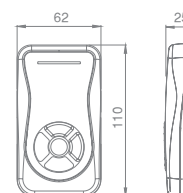

Wireless Range extender

Wireless Range extender

Wireless Range Extender was specially designed to extend the scope of Wireless systems where, due to architectural features or environmental conditions, wireless signal is attenuated, hindering communication between OnLED Control Motion and OnLED Wireless projectors.

Wireless Range extender es un producto especialmente diseñado para ampliar el alcance de la señal del sistema Wireless en instalaciones dónde debido a características arquitectónicas o condiciones ambientales la señal wireless queda atenuada dificultando la comunicación entre el OnLED Control Motion y los proyectores OnLED Wireless.

I0890 Wireless Range extender
Wireless Range extender

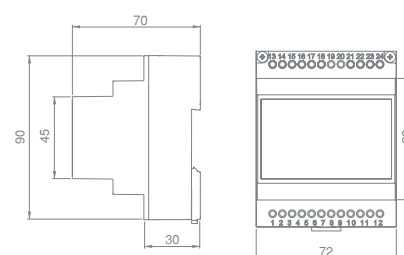

OnLED Action Remote Control

Control remoto OnLED Action

System of remote control by the wireless projector On/Off and change the colour and changing programmes. Vertical or horizontal movement permit change colours and secuencies of the wireless projector.

Sistema de control de los proyectores wireless al encendido y apagado, el cambio de colores de la luminaria con diferentes secuencias. El movimiento vertical o horizontal permite el cambio de colores o a las secuencias del proyector Wireless

I0875 OnLED Action Remote control
Control remoto OnLED Action

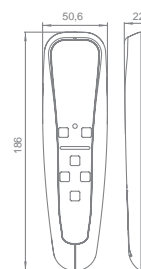

Underwater lighting | iluminación subacuática



Basic OnLED

Electric diagram that is obtained through the Pushbutton (n/c) (I0831) + Safety transformer.

The size of the transformer depends on the number of spotlights that are installed and their consumption. An input of 12V AC must reach the lamp. With every click, it changes colour or program, offers a range of 7 colours, as well as 7 colour changing programs.

Esquema eléctrico que se consigue mediante el Pulsador (n/c) (I0831) + Transformador de seguridad.

El transformador debe estar dimensionado respecto al número de proyectores que se instalan y su consumo. Siempre deben llegar 12V AC al proyector. Con cada pulsación realizada cambia de color o programa, ofrece una gama de 7 colores, así como 7 programas de cambios de color.

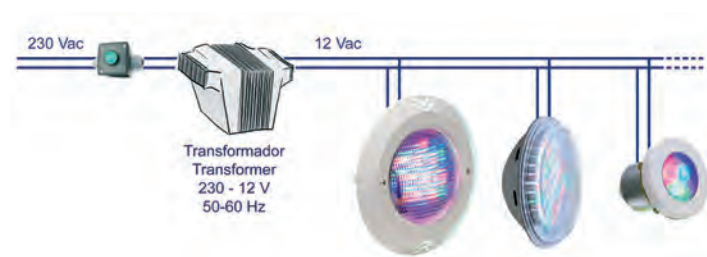

Total OnLED

Outline based on the OnLED Modulator, for increasing the number of colours and sequences of the spotlights. With it, it is possible to turn the spotlight on and off, change 12 colours and 8 sequences and control the speed of the sequences and the power off timer. The Modulator also has an antennae with that can reach up to 50m. with which it can be synchronized with the OnLED Remote Control (I0828).

The Modulator should be installed before the safety transformer and is connected to 230V AC through two terminals indicated as RED and is connected to the transformer primary through two terminals indicated with TRF. It is recommended to install the Modulator ensuring it is protected from corrosive environments.

Esquema basado en el Modulador OnLED, para ampliar el número de colores y de secuencias de los proyectores. Con él podrá controlar el encendido y apagado del proyector, cambio de 12 colores y 8 secuencias, velocidad de las secuencias y temporización del apagado. El Modulador dispone de una antena con un alcance de 50m. con la cual se puede sintonizar con el Control Remoto OnLED (I0828).

El Modulador se debe instalar antes del Transformador de seguridad y se conecta a 230V AC mediante dos bornes indicados como RED y se conecta al primario del transformador mediante dos bornes indicados con TRF, se recomienda instalar el Modulador protegido de ambientes corrosivos.

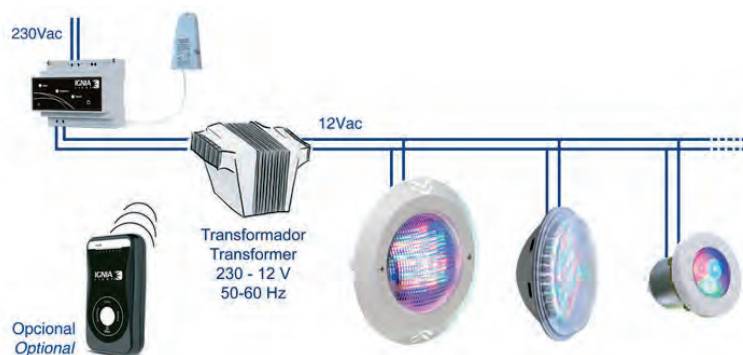

WiFi OnLED

Application for controlling any OnLED lamp or projector from smartphones/ tablets using an Android or iOS system (iPhone/iPad).

By free downloading the OnLED onto your smartphone or tablet, you will be able to change the colours, sequences, speed, and time you wish to switch off your OnLED lamps and projectors.

Aplicación para controlar cualquier lámpara o proyector OnLED desde smartphones/tablets con sistema Android o iOS (iPhone/ iPad).

Descargando gratuitamente la aplicación OnLED al smartphone o tablet podrá activar el cambio de color, las secuencias y su velocidad o la temporización de apagado de las lámparas y proyectores OnLED.

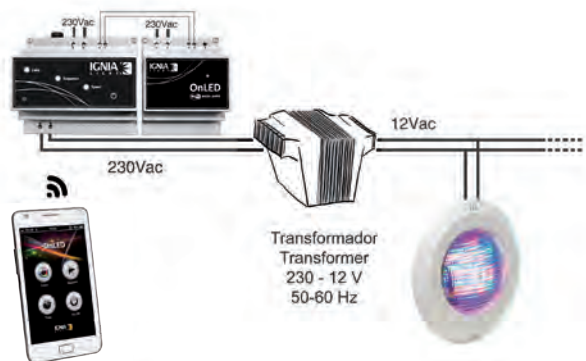

OnLED Wireless

The OnLED Action Remote Control sends orders directly to the OnLED RGB V1 wireless lamps which does not need external control modules. A motion sensor enables colours and sequences to be changed through movement. Also pressing the push button change the colour, the sequences and their speed, and switch on or switch off the OnLED RGB V1 wireless lamps.

OnLED Action Remote Control envía directamente las órdenes a las lámparas OnLED RGB V1 wireless sin necesidad de módulos de control externos. El sensor de movimiento permite el cambio de colores y secuencias a través de movimientos. Además la pulsación de botones activa el cambio de color, las secuencias y su velocidad, y el encendido / apagado de las lámparas.



Range Extender page 67
Range Extender página 67



OnDMX

Those that want total control of the lighting can use the spotlights with DMX adaptation and OnDMX Control, and then they can independently control all the spotlights, and obtain more than 16.000.000 colours and infinite sequences.

Aquellos que quieran un control total de la iluminación pueden utilizar los proyectores con adaptación DMX y con Control OnDMX, con la que podrán controlar todas las luminarias independientemente, pudiendo conseguir más de 16.000.000 de colores e infinidad de secuencias.

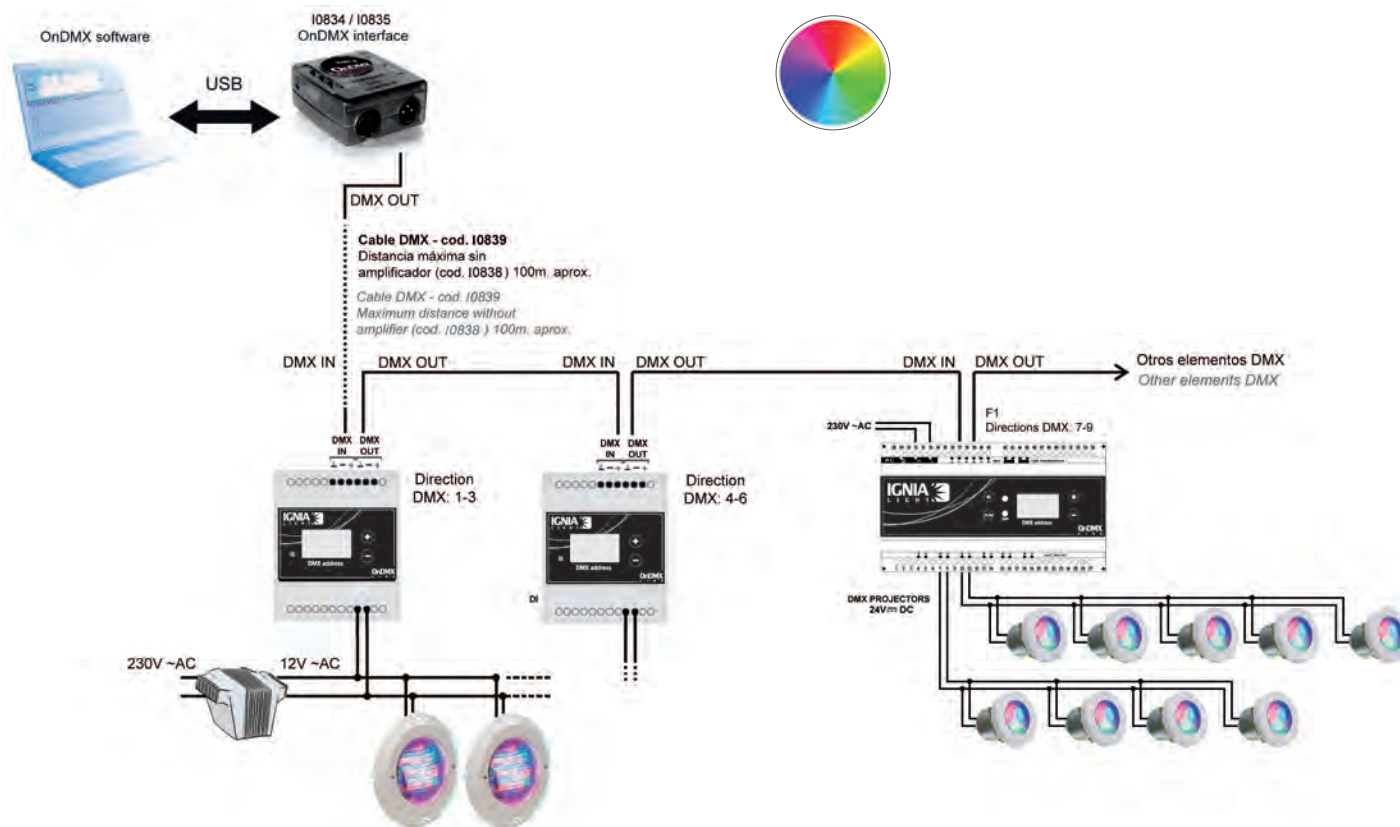

A nighttime photograph of a fountain. In the center, a statue of a seated figure on a lion is illuminated with warm, golden light. To the left, a tall, thin water column is lit with a bright, cool blue light. The fountain's tiers are lit with a mix of green and blue lights, creating a vibrant, multi-colored effect. In the background, a large, ornate building with a tower is visible, also illuminated with blue and purple lights. The overall scene is a dramatic display of architectural lighting.

Accessories
Accesorios



Niches Nichos

Niches to install STD lamps in underwater installations or swimming pools. They come in different versions for concrete pools, prefabricated pools (polyester) and galvanised panel pools.

They are manufactured in plastic and include a packing gland to guarantee watertightness in the connection cable. The niches for prefabricated pools are double injection moulded and include a sealing wall joint.

Nichos para instalar los proyectores STD en instalaciones acuáticas o piscinas. Hay versiones para piscinas de hormigón, piscinas prefabricadas (de poliéster) y piscina de paneles de chapa galvanizada o plástico.

Fabricados en plástico, incorporan el prensaestopas para garantizar la estanquidad en el cable de conexionado. Los nichos para piscinas prefabricadas, son de doble inyección e incorporan la junta de estanquidad para la pared.



- I0861 Concrete pool niche
Nichos piscina hormigón
- I0862 Prefabricated pool niche with metallic inserts
Nichos piscina prefabricada con injertos
- I0863 Prefabricated pool niche without metallic inserts
Nichos piscina prefabricada sin injertos
- I0864 Panels pool niche with metallic inserts
Nichos piscina de paneles con injertos
- I0865 Panels pool niche without metallic inserts
Nichos piscina de paneles sin injertos



I0883 Niche for liner pools (for Broc STD/ Broc Mini)
Nichos piscina liner (para Broc STD/ Broc Mini)



I0884 Broc STD /Broc Mini adapters Ø63 PN-6 / PN-10 / 2"
Adaptadores Broc STD/ Broc Mini Ø63 PN-6 / PN-10 / 2"



- I0872 Niche for concrete pools, spotlight
Nichos piscina hormigón, punto de luz
- I0880 Niche for concrete pools, rapid coupling system
Nichos piscina hormigón, acople rápido
- I0879 Niche for prefabricated pools
Nichos piscina prefabricada

Power supply

Fuente de alimentación

Power supply by LED technology products, especially designed for use in aquatic installations like pools or fountains.

Fuentes de alimentación para productos con tecnología LED especialmente diseñadas para utilizarse en instalaciones acuáticas como piscinas y fuentes.

- I0847 Power supply DIN 24Vdc 480W
Fuente Alimentación carril DIN 24Vdc 480W
- I0898 Power supply DIN 24Vdc 120W
Fuente Alimentación carril DIN 24Vdc 120W
- I0899 Power supply DIN 24Vdc 240W
Fuente Alimentación carril DIN 24Vdc 240W
- I0908 Power supply DIN 24Vdc 960W
Fuente Alimentación carril DIN 24Vdc 960W
- I0901 Power supply 150W SELV
Fuente Alimentación 150W SELV
- I0902 Power supply 240W SELV
Fuente Alimentación 240W SELV
- I0903 Power supply 16W SELV
Fuente Alimentación 16W SELV
- I0904 Power supply 40W SELV
Fuente Alimentación 40W SELV



Safety transformers

Transformadores de seguridad

Single-phase Safety Transformers, especially designed for use in aquatic installations like pools or fountains.

Transformadores Monofásicos de Seguridad, especialmente diseñados para utilizarse en instalaciones acuáticas como piscinas y fuentes.

With the protection degree IP20 or more, primary of 230V AC and secondary of 12-13-14V AC.

Con grado de protección IP20 o superior, primarios de 230V AC y secundarios de 12-13-14V AC.

- I0820 Safety transformer 350 VA
Transformador de seguridad 350 VA
- I0821 Safety transformer 130 VA
Transformador de seguridad 130 VA
- I0823 Safety transformer 700 VA
Transformador de seguridad 700 VA
- I0822 Safety transformer IP65 350 VA
Transformador de seguridad IP65 350 VA



Vulcanised Kit Kit Vulcanizado

Underwater connection, used to seal an underwater electrical connection with maximum safety. It is easy to install and thanks to its small size, an electric connection can be sealed in any space even if it is small and difficult to access.

The kit contains all the components needed to make all connections in a completely water-sealed installation. Once they have set, the resins fully insulate the water connection.

Conexión subacuática, indicada para sellar una conexión eléctrica subacuática con la máxima seguridad. De fácil instalación y gracias a sus reducidas dimensiones permite sellar una conexión eléctrica en cualquier lugar, aunque el espacio sea reducido y de difícil acceso.

El kit contiene todos los componentes necesarios para hacer de cualquier empalme, una instalación completamente estanca al agua. Una vez solidificadas, las resinas aíslan completamente la conexión del agua.



- I0817 Vulcanised kit cable 13-15mm.
Kit vulcanizado cable 13-15mm.
- I0818 Vulcanised kit cable 8-12mm.
Kit vulcanizado cable 8-12mm.

Waterproof connection Conexión estanca

Family of small connectors ideal for connections if space is limited. With an IP68 rating of up to 2 bar and metal inserts for the connections.

Familia de conectores de reducidas dimensiones ideal para conexiones en espacios pequeños. Con un grado de protección IP68 hasta 2 Bar e insertos metálicos para las conexiones.



- I0892 4 pole connection (Kit 5 unities + 2 keys)
Conexión 4 polos (Kit 5 und + 2 llaves)
- I0912 Air connector IP68 4 poles
Conector aéreo IP68 4 polos
- I0913 Air connector IP68 4 poles XDRY
Conector aéreo IP68 4 polos XDRY
- I0914 Key for aerial connector
Llave para conector aéreo
- I0916 IP68 connector T3 poles
Conector IP68 T3 polos

Photometry
Fotometrías

IGNIA
L I G H T

IGNIA
L I G H T

PAR56 V1
Monocolour/ monocolor

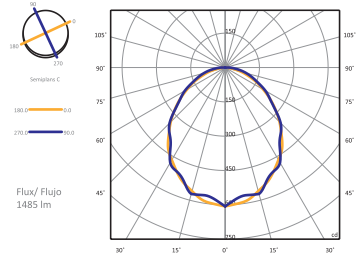
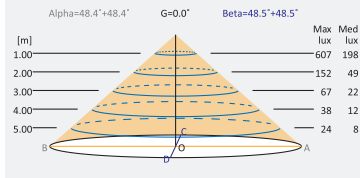

PAR56 V1
Multicolour/ multicolor

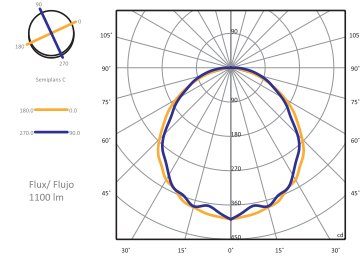
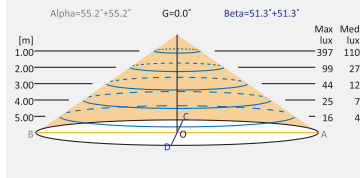

PAR56 V2
Multicolour/ multicolor

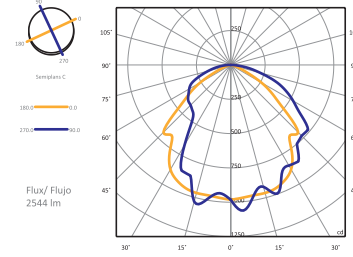
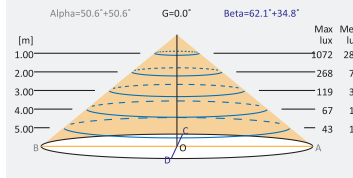

PAR56 V1 24VDC
Monocolour/ monocolor

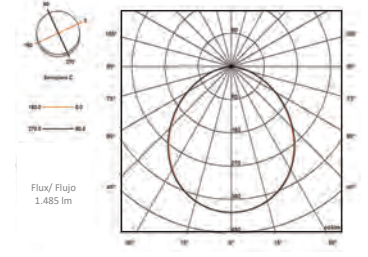
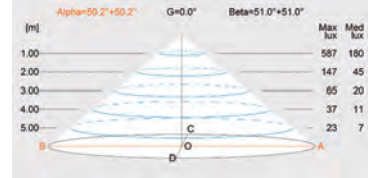

PAR56 V2 24VDC
Monocolour/ monocolor

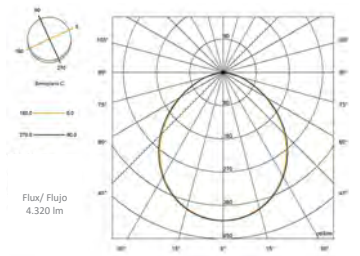
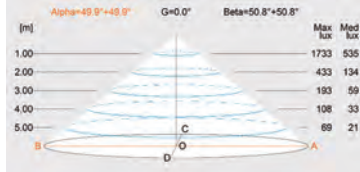

HALOSPOT
Monocolour/ monocolor

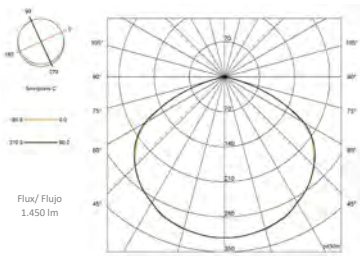
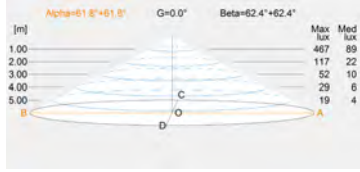

HALOSPOT
Monocolour/ monocolor Optic W

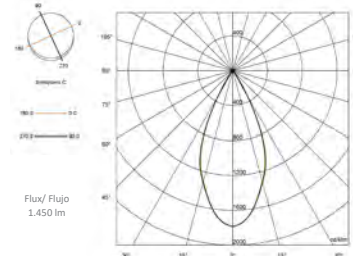

HALOSPOT
Monocolour/ monocolor Optic N

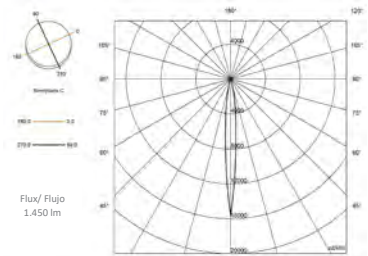

HALOSPOT
Monocolour/ monocolor Optic M

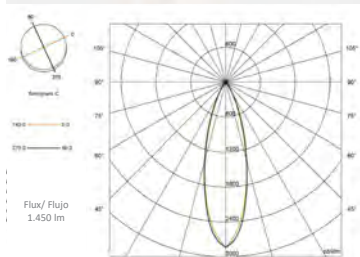

HALOSPOT
Multicolour/ multicolor

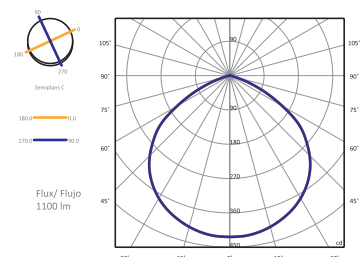
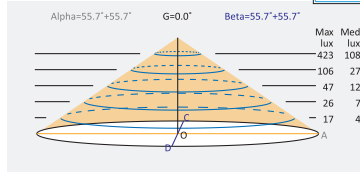

HALOSPOT
Multicolour/ multicolor Optic W

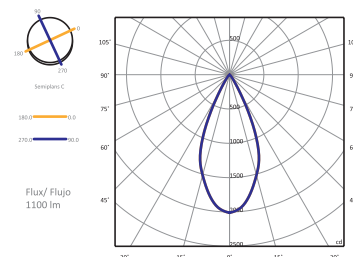
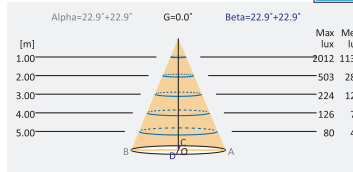

HALOSPOT
Multicolour/ multicolor Optic N

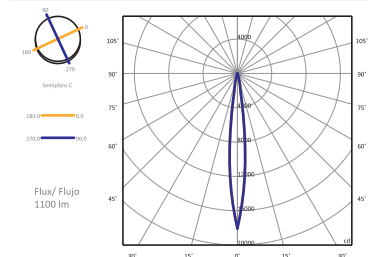
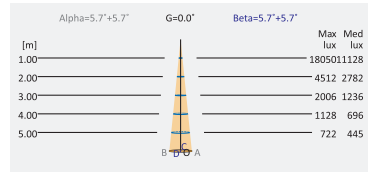

HALOSPOT
Multicolour/ multicolor Optic M

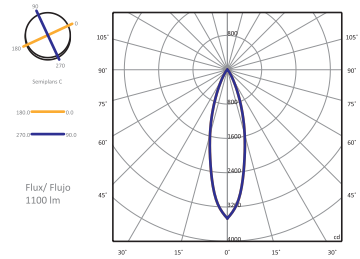
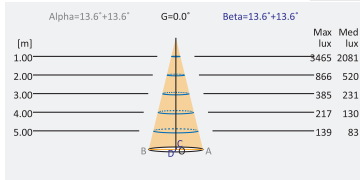

HALOSPOT
MWDMX/ MWDMX

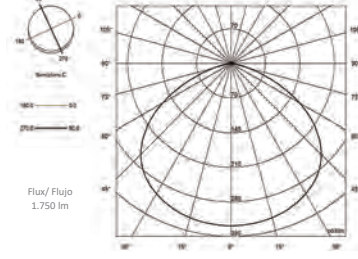
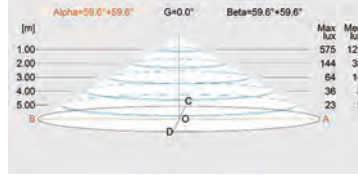

HALOSPOT
MWDMX/ MWDMX Optic W

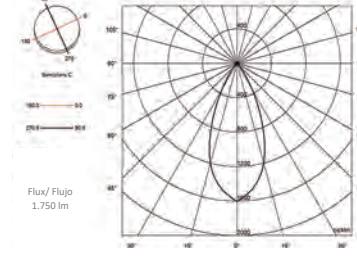
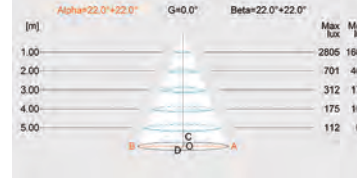

HALOSPOT
MWDMX/ MWDMX Optic N

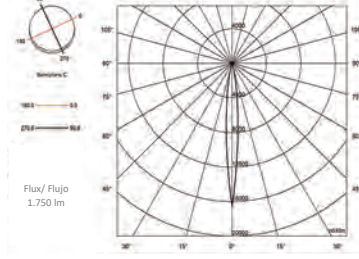

HALOSPOT
MWDMX/ MWDMX Optic M

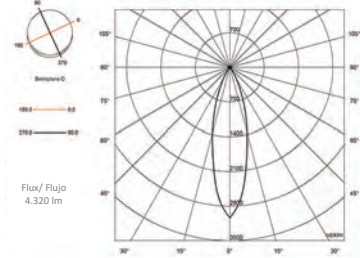

NIQ
Multicolour/ multicolor Optic N

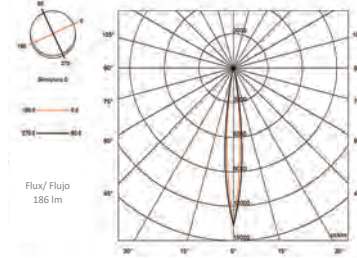

NIQ
Multicolour/ multicolor Optic W

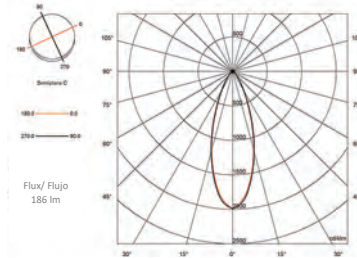

NIQ
Monocolour/ monocolor Optic N

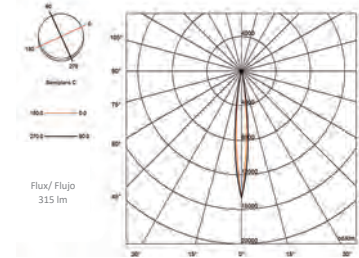
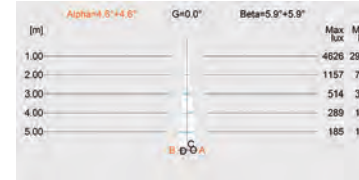

NIQ
Monocolour/ monocolor Optic W

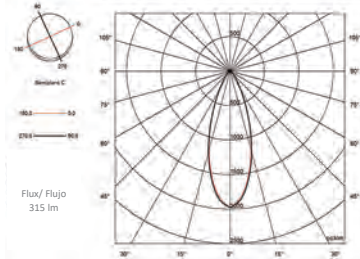

MINI
Monocolour/ monocolor Optic W

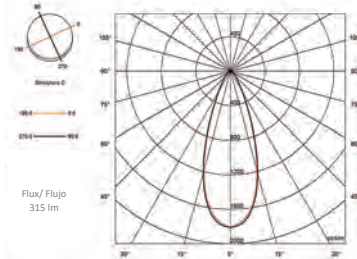

MINI
Monocolour/ monocolor Optic N

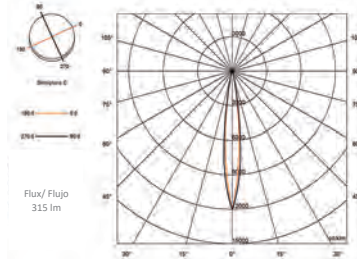

MINI
Monocolour/ monocolor Optic M

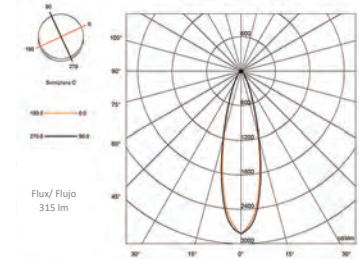
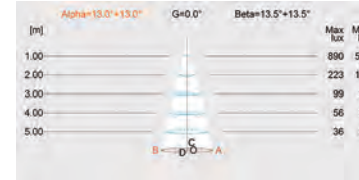

MINI
Multicolour/ multicolor Optic W

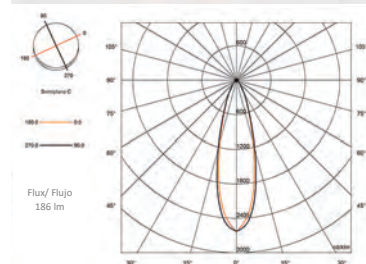

MINI
Multicolour/ multicolor Optic N

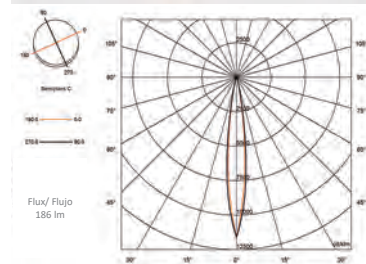

MINI
Multicolour/ multicolor Optic M

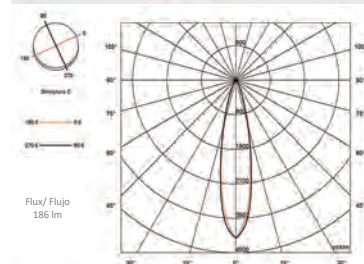

MINI
MWDMX/ MWDMX Optic W

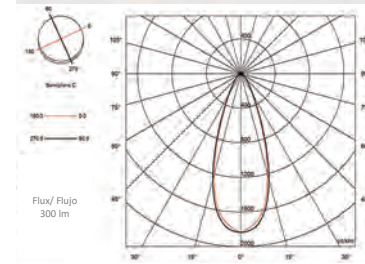

MINI
MWDMX/ MWDMX Optic M

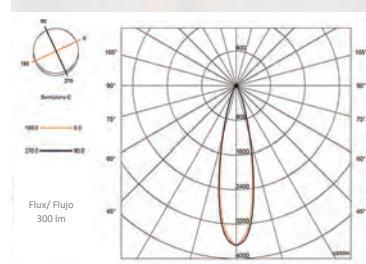
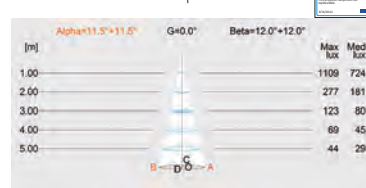

MINI
MWDMX/ MWDMX Optic N

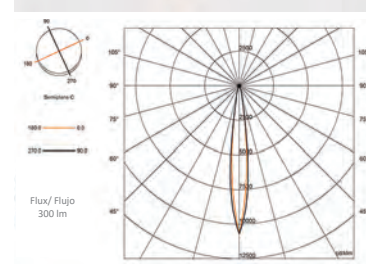

MINI +
Multicolour/ multicolor Optic N

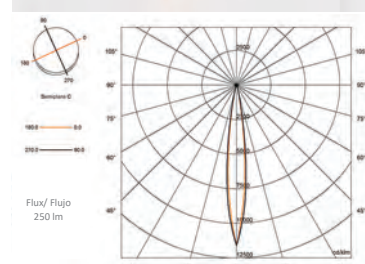

MINI +
Multicolour/ multicolor Optic M

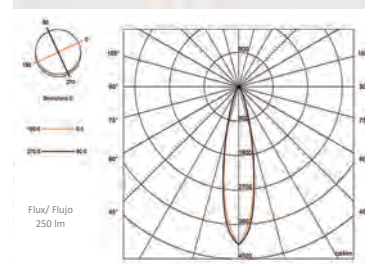

MINI +
Multicolour/ multicolor Optic W

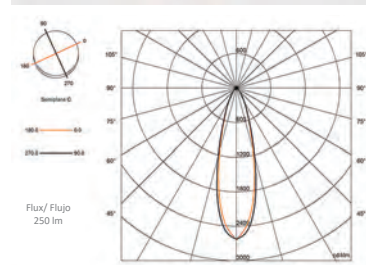
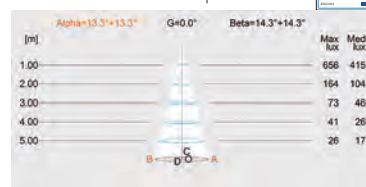

MINI +
Monocolour/ monocolor Optic N

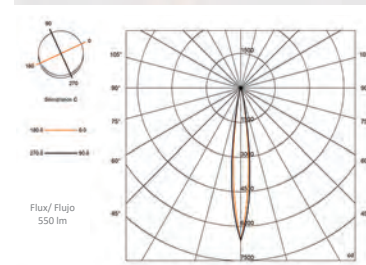

MINI +
Monocolour/ monocolor Optic M

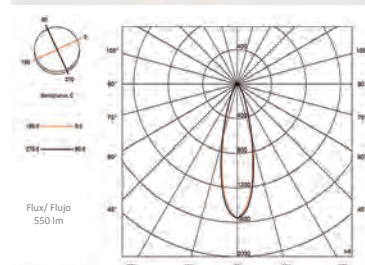
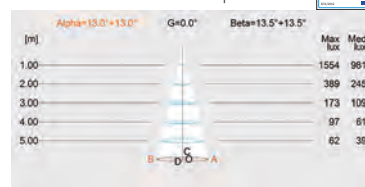

MINI +
Monocolour/ monocolor Optic W

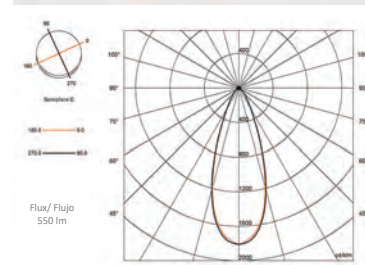
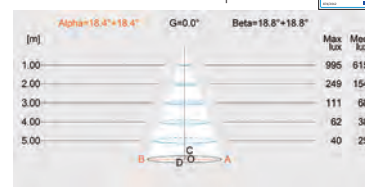

MINI +
MWDMX/ MWDMX Optic N

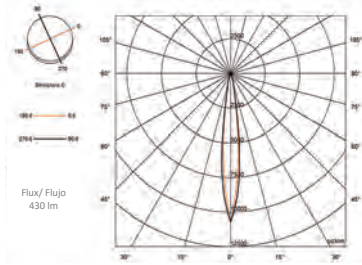
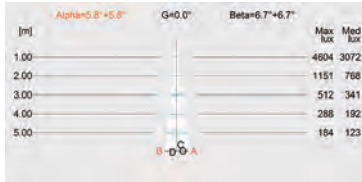

MINI +
MWDMX/ MWDMX Optic M

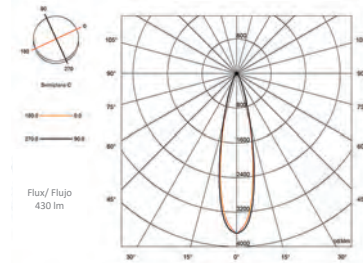
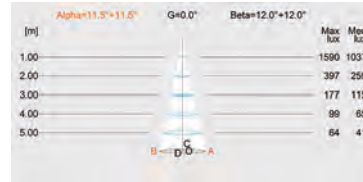

MINI +
MWDMX/ MWDMX Optic W

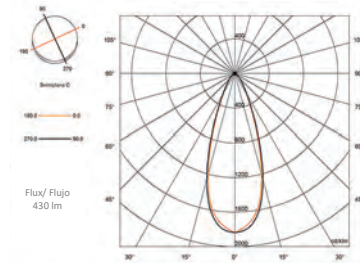

STD Projector V1
Monocolour/ monocolor

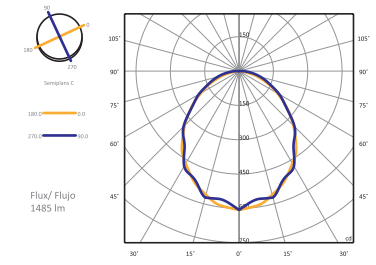
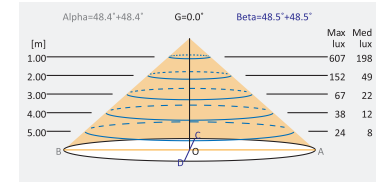

STD Projector V1
Multicolour/ multicolor

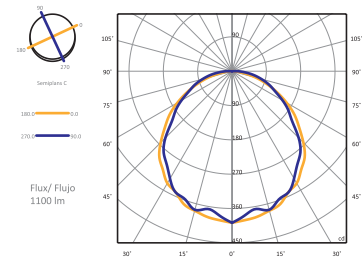
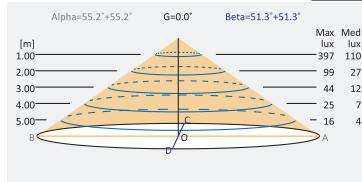

STD Projector V2
Multicolour/ multicolor

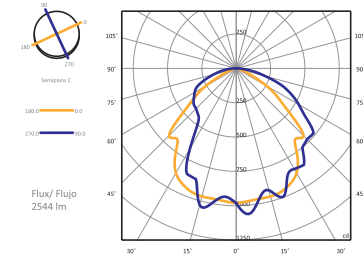
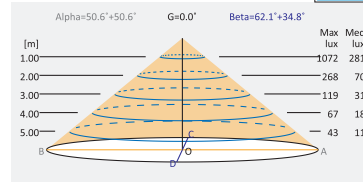

STD Projector V1 24VDC
Monocolour/ monocolor

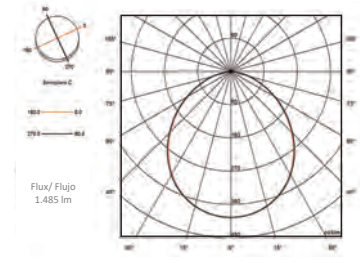
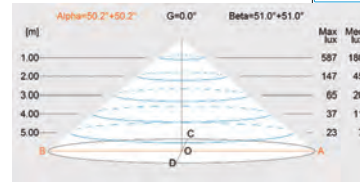

STD Projector V2 24VDC
Monocolour/ monocolor

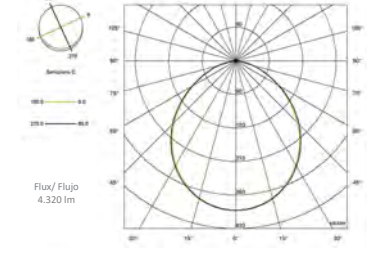
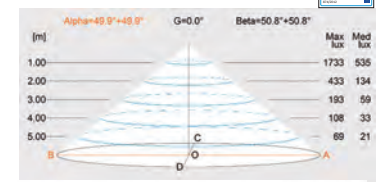

FLAT V1 / PLANO V1
Monocolour/ monocolor

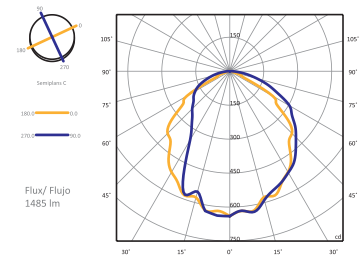
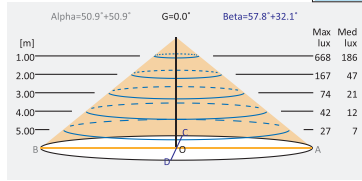

FLAT V1/ PLANO V1
Monocolour/ monocolor

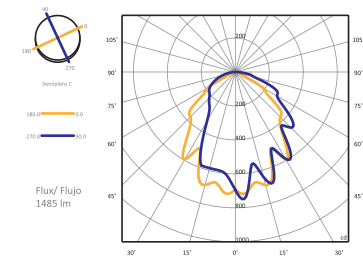
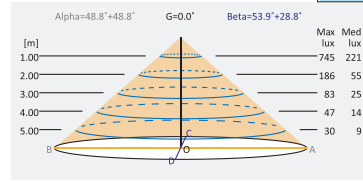

FLAT V2/ PLANO V2
Multicolour/ multicolor

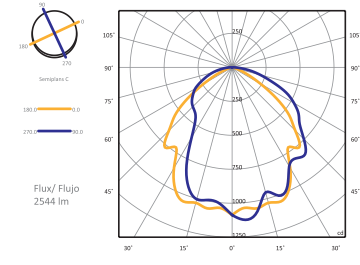
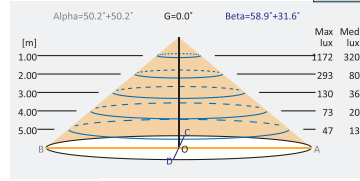

FLAT V2 / PLANO V2
Monocolour/ monocolor

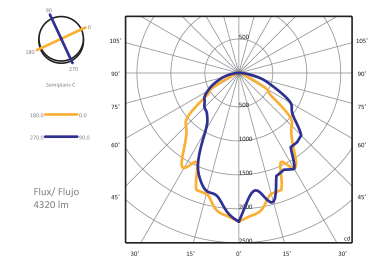
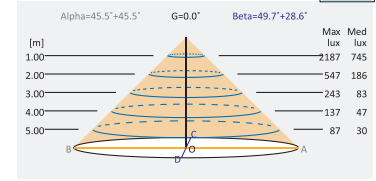

BROC STD
Monocolour/ monocolor

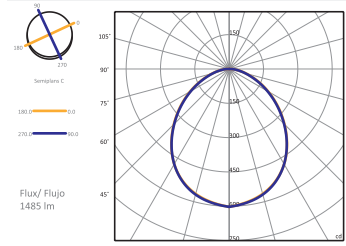
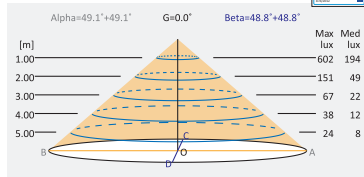

BROC STD
Multicolour/ multicolor

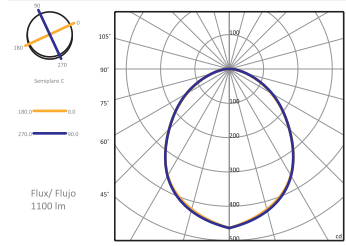
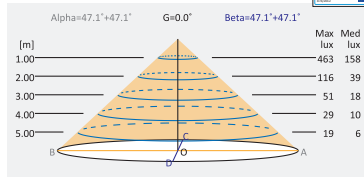

BROC Mini
Monocolour/ monocolor

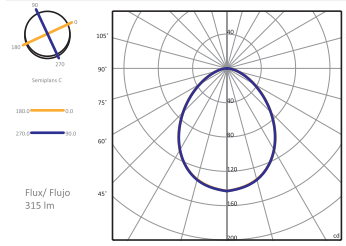
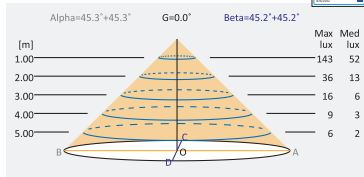

BROC Mini
Multicolour/ multicolor

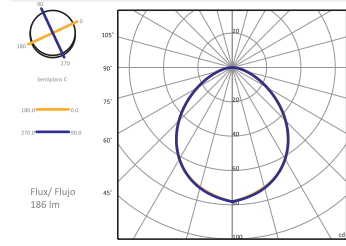
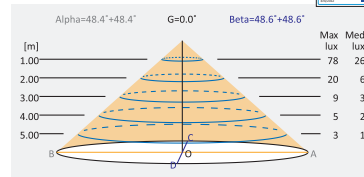

KIBELE
Monocolour/ monocolor

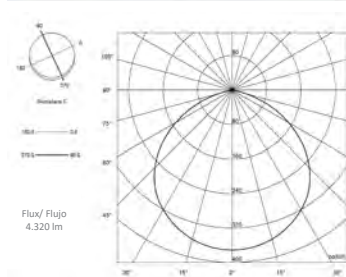
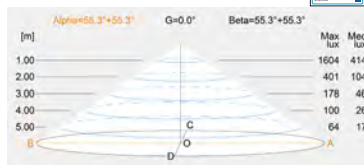

KIBELE
Monocolour/ monocolor Optic M

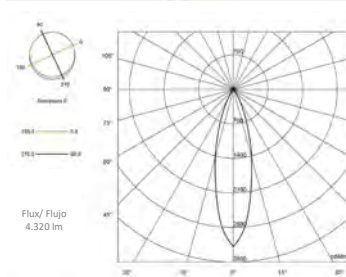

KIBELE
Monocolour/ monocolor Optic N

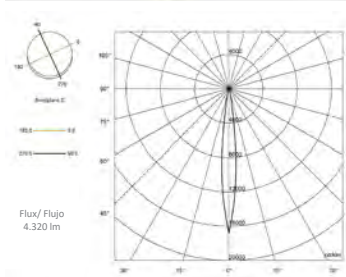

KIBELE
Monocolour/ monocolor Optic W

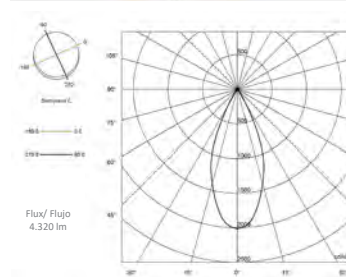

KIBELE
Multicolour/ multicolor

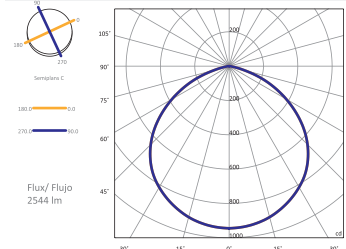
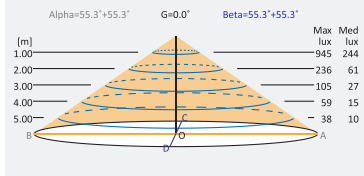

KIBELE
Multicolour/ multicolor Optic M

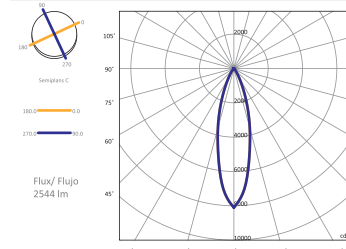
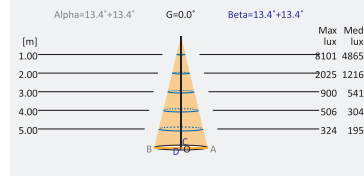

KIBELE
Multicolour/ multicolor Optic N

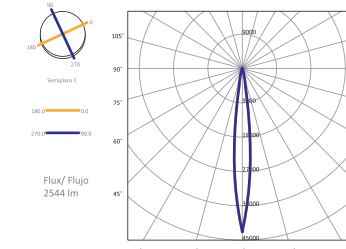
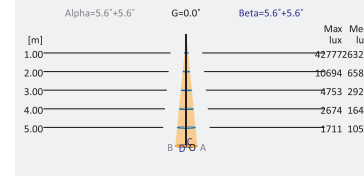

KIBELE
Multicolour/ multicolor Optic W

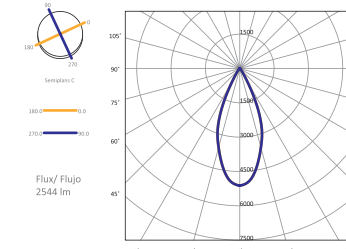
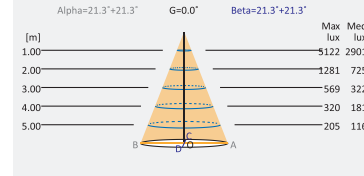

KIBELE
MWDMX/ MWDMX

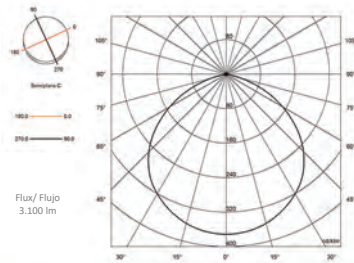
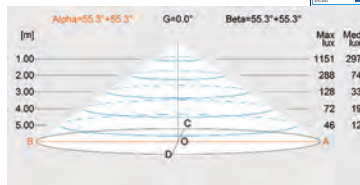

KIBELE
MWDMX/ MWDMX Optic M

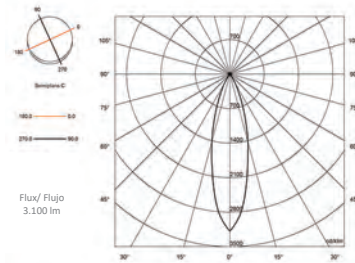
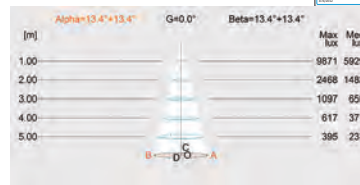

KIBELE
MWDMX/ MWDMX Optic N

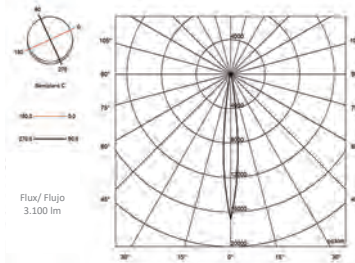

KIBELE
MWDMX/ MWDMX Optic W

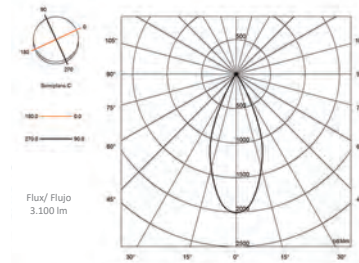
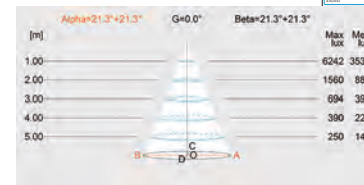

NANO
Multicolour/ multicolor Optic N

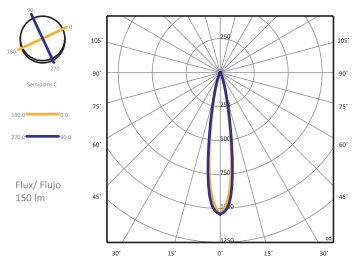
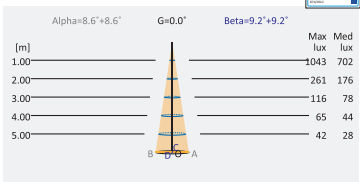

NANO
Multicolour/ multicolor Optic W

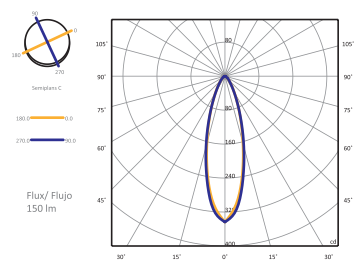
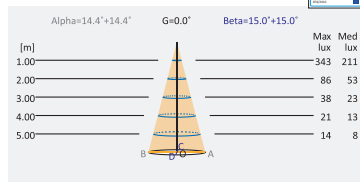

NANO
Monocolour/ monocolor Optic N

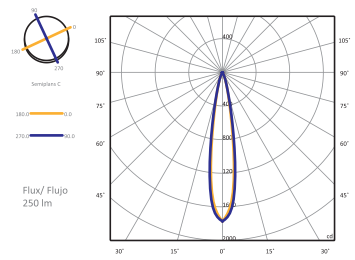
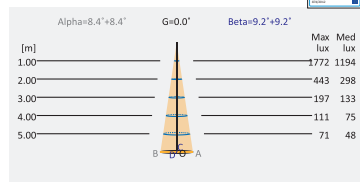

NANO
Monocolour/ monocolor Optic W

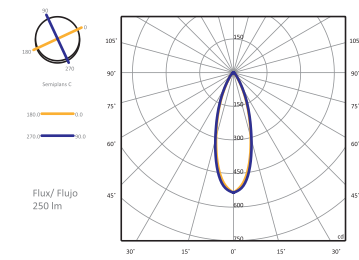
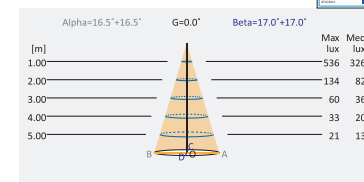

Circular Ø200
MWDMX/ MWDMX

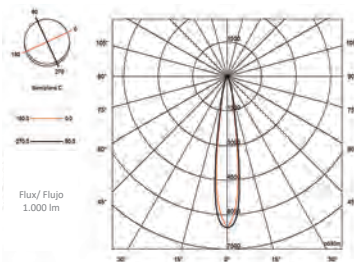
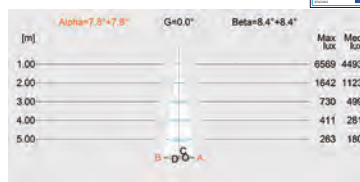

Circular Ø200
Monocolour/ monocolor

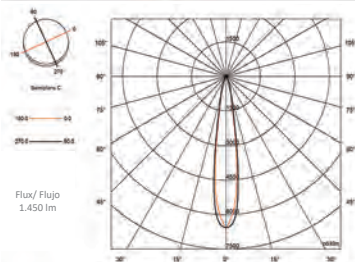

Circular Ø300
MWDMX/ MWDMX

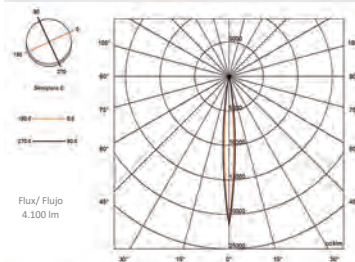

Circular Ø300
Monocolour/ monocolor

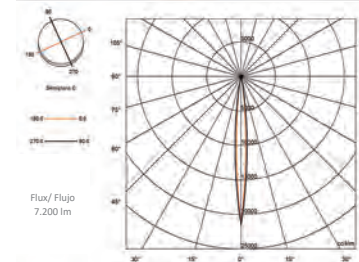

Adjustable linear projector
MWDMX/ MWDMX

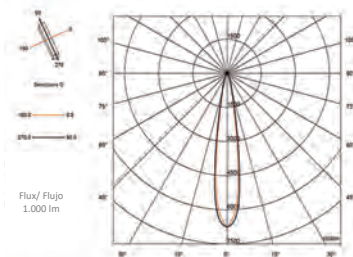

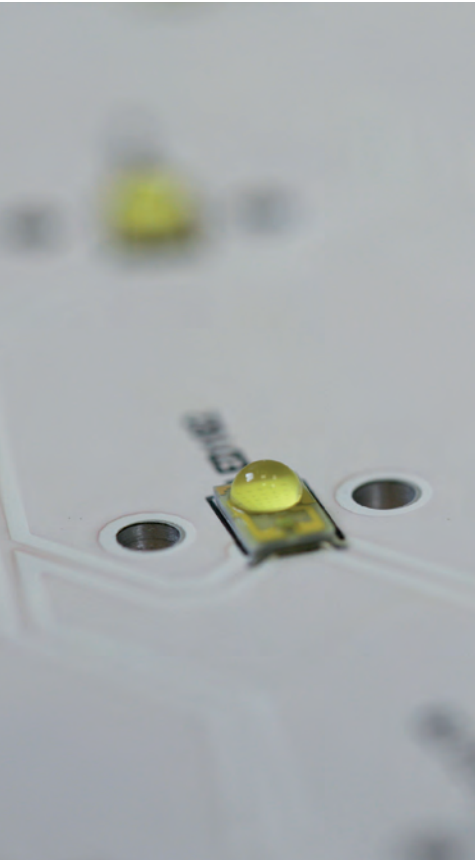

Materials

STAINLESS STEEL PRODUCTS

Stainless steel is a steel that is resistant to corrosion, given that the chrome that it contains has a great affinity for oxygen and reacts with it by forming a passive layer of approximately one atom of thickness, avoiding the corrosion with iron. However, this layer can be affected by some acids, provoking the iron to be attacked and rusted by intergranular mechanisms or generalized pitting.

The steel that we always use at IGNIALIGHT for our products is of the type AISI 304, AISI 316 y AISI 316L. Small marks may appear on this stainless steel as a

result of the contact with the marine atmosphere, humid environments as well as the lime that comes from watering. This type of contamination on the stainless steel will be eliminated by applying cleaning products that contain phosphorus acid.

ALUMINIUM PRODUCTS

The IGNIALIGHT products that are completely or partially made out of aluminium have been protected with anti-rust paints to ensure long durability, however our products may still deteriorate due to:

- The existing current in the ground or installation.
- The lack of quick protection of the aluminium in

the event of the paint coming off from rubbing or banging.

TERMOPLASTICS PRODUCTS

The components manufactured by IGNIALIGHT completely or partially in plastic are especially designed for having great resistance to humidity, weathering and its deterioration can be produced by:

- Misuse or high impact.
- Installation in spaces with high temperatures.
- Contact with highly acidic chemical products.

Materiales

PRODUCTOS DE ACERO INOXIDABLE

El acero inoxidable es resistente a la corrosión, dado que el cromo que contiene posee gran afinidad por el oxígeno y reacciona con él formando una capa pasivadora de aproximadamente un átomo de grosor, evitando así la corrosión. Sin embargo esta capa puede ser afectada por algunos ácidos, dando lugar a que el hierro sea atacado y oxigenado por mecanismos intergranulares o picaduras generalizadas.

El acero inoxidable utilizado en los productos IGNIALIGHT es del tipo AISI 304, AISI 316 y AISI 316L. Sobre este acero inoxidable pueden aparecer pequeñas manchas como resultado del contacto con la atmós-

fera marina, ambientes húmedos así como la cal y otros químicos provenientes de los riegos. Este tipo de contaminación sobre el acero inoxidable se eliminará con la aplicación de productos limpiadores que contengan ácido fosfórico.

PRODUCTOS DE ALUMINIO

Los productos de IGNIALIGHT fabricados totalmente o parcialmente con aluminio han sido protegidos con pinturas antioxidantes para asegurar una larga durabilidad, aún así nuestros artículos pueden deteriorarse a causa de:

- La corriente vagante existente en el terreno o instalación.

- La no protección rápida del aluminio en el caso de verse arrancada la pintura por roce o golpe.

PRODUCTOS TERMOPLÁSTICOS

Los componentes fabricados por IGNIALIGHT total o parcialmente en plástico, están especialmente diseñados para tener gran resistencia a la humedad y a la intemperie, su deterioro puede producirse por:

- Maltrato o fuerte impacto.
- Instalación en espacios con altas temperaturas.
- Contacto con productos químicos de mucha acidez.

Installation advices/ recomendations

Under no circumstances will IGNIALIGHT be responsible for assembling, installing or starting up the luminaires or for any manipulation or incorporation of electric components that do not come from their installations.

You must disconnect the fixture from power before working on or performing any maintenance.

The maintenance or replacement of any component must be made with identical or failing with those recommended by IGNIALIGHT.

OUTDOOR LIGHTING

Follow the assembly instructions closely during the installation and maintenance operations.

The cable used for the lamp's exterior connections must comply with the Low-Voltage Electrical Regulations.

People will assemble must possess the necessary qualifications for such jobs.

Comply with the current standards regarding accident prevention.

Consejos de instalación/ recomendaciones

IGNIALIGHT en ningún caso se responsabiliza del montaje, instalación o puesta en funcionamiento de sus luminarias ni de cualquier manipulación o incorporación de componentes eléctricos que no se hayan llevado a cabo en sus instalaciones.

Se debe desconectar la luminaria del suministro eléctrico antes de manipular o realizar cualquier tipo de mantenimiento.

El mantenimiento o reposición de cualquiera de los componentes deberá realizarse con elementos idénticos o en su defecto con los recomendados por IGNIALIGHT.

LÁMPARAS DE ILUMINACIÓN EXTERIOR

Siga detenidamente las instrucciones de montaje durante la instalación y operaciones de mantenimiento.

El cable utilizado para realizar conexiones exteriores de la luminaria debe cumplir la normativa vigente en el "Reglamento electrotécnico para baja tensión".

Las personas que se encarguen del montaje deben poseer la calificación requerida para este tipo de trabajos.

Se deben respetar las normas vigentes para la prevención de accidentes.

General terms and conditions of sale

1. INCLUSION IN THE CONTRACT: These GENERAL TERMS AND CONDITIONS OF SALE will apply to any sale or delivery of goods agreement entered into by the SELLER. The SELLER contracts the sale of the GOODS pursuant exclusively to these TERMS AND CONDITIONS. Whatsoever terms and conditions other than those set out herein, including those contained in delivery notes or orders issued by the BUYER, will have no effect whatsoever, unless expressly accepted in writing by both parties. When an order is placed, the BUYER declares that it has already read and is familiar with these TERMS AND CONDITIONS, and accepts each and every one of the clauses thereof, together with the express inclusion thereof in the agreement.

2. ORDERS AND ACCEPTANCE: At its absolute discretion, the SELLER may accept or reject whatsoever order received from the BUYER. The agreement shall come into effect upon SELLER's acceptance of the purchase order. Before accepting whatsoever order, the SELLER may extend or suspend the range of products or whatsoever part thereof.

3. PRICE: All the prices must be considered as net, in euros and with no deduction whatsoever. Unless expressly agreed to the contrary, the prices do not include taxes, duties or other charges or costs, such as haulage costs, general or special costs, which will be on the BUYER's account, taking into account the INCOTERMS 2000 that may apply and/or the terms and conditions of delivery of the goods. Without prejudice to the provisions of the foregoing paragraph, the SELLER hereby reserves the right to increase the price of the GOODS before accepting an order if said increase is due to an increase in the cost of raw materials, labour, whatsoever legislative change or to whatsoever other cause that cannot be reasonably avoided by the SELLER.

4. METHOD OF PAYMENT: Except in the case of a written AGREEMENT to the contrary, each order will be paid in cash with no discount whatsoever and without the possibility of the BUYER deducting, compensating or retaining payments. In whatsoever case, the expenses arising from the method of payment that is chosen will be on the BUYER's account.

5. DELIVERY AND TRANSFER OF RISK: Unless expressly provided for by the parties to the contrary, the delivery and transfer of risk shall be made ex-works in accordance with the INCOTERMS 2000. Accordingly, it will be understood that the SELLER meets its obligation of delivery at the time the GOODS are made available to the BUYER at the door of the SELLER's warehouse, immediately prior to their loading for haulage, which will be considered for all intents and purposes as the place to which all the contractual obligations correspond.

6. TERM OF DELIVERY: The term of delivery will begin from the time the order is confirmed by the SELLER. The term of delivery will be considered as completed when the delivery is ready for shipment in the agreed place. The term of delivery shall be extended if there

are reasonable grounds beyond the control of the SELLER that prevent the delivery on the date agreed upon or if the BUYER changes its original order or falls behind in its contractual obligations.

7. BREACH OF THE DELIVERY OR RECEPTION: Should the BUYER fail to collect the GOODS or any part thereof on the agreed dates and in the agreed places, the SELLER may, at its choice, cancel said delivery and whatsoever other deliveries that may be pending and charge the BUYER with all the losses caused, or store the GOODS on the BUYER's account, cost and risk.

8. ACCEPTANCE OF THE GOODS: The BUYER will review and complete the check of the GOODS with regard to quality and quantity at the time they are delivered. After the GOODS have been checked, they will be considered to have been accepted by the BUYER, who hereby waives whatsoever right to whatsoever claim.

9. RETENTION OF TITLE: The SELLER will keep the ownership of the supplied GOODS until the reception of all the payments agreed with the BUYER. Should the BUYER enter into default on any of its payment obligations, the SELLER will be authorised to directly recover the possession of the GOODS and remove them from the place where they have been stored without the need for whatsoever court ruling.

10. DESCRIPTION AND GUARANTEES: The SELLER hereby guarantees that, on the delivery date, the GOODS are, to the best of his knowledge and understanding, in compliance with the specifications agreed on in the order. The SELLER's may not be held liable for whatsoever non-conformities that are beyond its control. The guarantee likewise excludes the GOODS on which the BUYER or whatsoever third party has completed or started repair work, modifications or adjustments without the SELLER's prior consent. The specific TERMS AND CONDITIONS of the guarantee with regard to the end consumer are delivered to the BUYER with the GOODS.

11. DAMAGES AND LIMIT TO LIABILITIES: Any claims against the guarantee and liability actions are covered in full by these TERMS AND CONDITIONS. Unless provided for in governing law, the SELLER will not respond for whatsoever contractual or extra-contractual damage, such as damage caused by loss of production, use, orders, profits (including *lucrum cessans*) or whatsoever other direct, indirect or consequential damage. Unless agreed otherwise, the SELLER's responsibility for damages that may be caused to the BUYER will not exceed the value of the GOODS affected at the time of sale under any circumstances. The SELLER's prices are drawn up and negotiated on the basis that its maximum legal liability will be limited. If the BUYER so wishes, the SELLER may negotiate higher limits to its liability, subject to the corresponding proportional increase of the price. The SELLER will not be responsible for the damages that may be caused to the BUYER as a result of its acts or omissions or those of its employees or representatives in relation to the AGREEMENT or GOODS that exceed the purchase price thereof

and, where applicable, the installation price if said installation has been carried out by the SELLER, excluding VAT, customs duties, insurance premiums and costs other than those of the GOODS themselves.

12. FORCE MAJEURE: The concept of force majeure will apply for the intents and purposes of these TERMS AND CONDITIONS in the event of whatsoever contingency, circumstance or cause beyond the control of the party calling said concept. Should either of the parties be unable to fulfil whatsoever contractual obligation other than that of the payment of the price as a result of force majeure, said party will be exempted from said fulfilment as long as it notifies the other party of the commencement and nature of the situation of force majeure. The party calling force majeure must send immediate notice after the cause thereof has ended. The SELLER may not be held liable by the BUYER for whatsoever loss or damages arising from the non-fulfilment or the lack of specific or complete fulfilment of its obligations as a result of force majeure.

13. NONDISCLOSURE AND DATA PROTECTION: The personal information provided by the BUYER will be included in the SELLER's customer file, where the purposes of said file include the maintenance of the contractual relations, the control and management of the sales and their corresponding payment and the sending of information about the SELLER's products and services by whatsoever means. The SELLER will process said data under strict confidentiality and hereby undertakes not to use them for whatsoever purpose other than that for which they have been collected, as well as to keep them with the appropriate measures to guarantee their security and prevent their unauthorised alteration, loss, processing or access. The BUYER is entitled to exercise its rights to access, amend, cancel and contest its data by writing to the SELLER's address, care of the Data Protection Manager.

14. LANGUAGE: In the event of a discrepancy between the texts in Spanish and those in whatsoever other language of the AGREEMENT or whatsoever other documentation that refers to the sale of the GOODS, the text in Spanish will prevail.

15. GOVERNING LAW AND JURISDICTION: Whatsoever AGREEMENT subject to these TERMS AND CONDITIONS will be governed and interpreted in accordance with Spanish law. The parties hereby expressly waive their right to whatsoever other jurisdiction and submit to the courts and tribunals of the town of Sabadell (Barcelona, Spain) for whatsoever difference or litigation arising from the validity, interpretation, fulfilment or performance of the AGREEMENT, the General Terms and Conditions of Sale and the acts or transactions provided therein.

Condiciones generales de venta

1. INCORPORACIÓN AL CONTRATO: Las presentes CONDICIONES GENERALES DE VENTA serán aplicables a cualquier contrato de venta o entrega de mercancía realizada por el VENDEDOR. El VENDEDOR contrata la venta de las MERCANCIAS con sujeción, únicamente, a las presentes CONDICIONES. Cualesquiera otros términos y condiciones diferentes a las presentes CONDICIONES, incluidas las adjuntas en los albaranes o pedidos del COMPRADOR, no tendrán efecto alguno, salvo expresa aceptación por escrito firmado por Ambas Partes. Con la realización del pedido, el COMPRADOR declara haber leído y conocido con anterioridad las presentes CONDICIONES, y acepta todas y cada una de sus estipulaciones, así como su expresa incorporación al contrato.

2. PEDIDOS Y ACEPTACIÓN: El VENDEDOR podrá, a su absoluta discreción, aceptar o rechazar cualquier pedido recibido del COMPRADOR. Con la aceptación del pedido por el VENDEDOR el contrato se entenderá perfeccionado. Antes de la aceptación de cualquier pedido, el VENDEDOR podrá ampliar o suspender la gama de productos o cualquier parte de la misma.

3. PRECIO: Todos los precios deberán ser considerados como netos, en euros, y sin ninguna deducción. Salvo pacto expreso en contrario, los precios no incluyen impuestos, tasas u otras cargas o costes, como los de transporte, tanto de naturaleza general como especial, que serán a cargo del COMPRADOR, teniendo en cuenta los INCOTERMS 2000 que en su caso sean de aplicación y/o las condiciones de entrega de las mercancías. Sin perjuicio de lo indicado en el párrafo anterior, el VENDEDOR se reserva el derecho de aumentar el precio de las MERCANCIAS antes de la aceptación del pedido si dicho aumento se debe a un incremento en el coste de las materias primas, mano de obra, a cualquier cambio de legislación o a cualquier otra causa que el vendedor no pueda razonablemente evitar.

4. FORMA DE PAGO: Salvo pacto escrito en contrario, cada pedido se pagará al contado, sin ningún descuento y sin que se permita deducción, compensación o retención de pagos por parte del COMPRADOR. En todo caso, los gastos derivados del sistema de pago elegido serán de cuenta del COMPRADOR.

5. ENTREGA Y TRANSMISIÓN DEL RIESGO: Salvo acuerdo expreso de las partes en otro sentido, la entrega y transmisión del riesgo se entenderán efectuadas EX WORKS con arreglo a los INCOTERMS 2000. De este modo, se entenderá que el VENDEDOR cumple su obligación de entrega con la puesta de la MERCANCÍA a disposición del COMPRADOR en la puerta del almacén del VENDEDOR, inmediatamente antes de su carga para transporte, que será considerado, a todos los efectos, el lugar de realización de todas las obligaciones contractuales.

6. PLAZO DE ENTREGA: El plazo de entrega comenzará a computarse desde el momento de confirmación del pedido por parte del VENDEDOR. El plazo de entrega se considerará completado cuando la entrega esté lista para despachar en el lugar acordado. Será razonablemente ampliado si por motivos ajenos a la

voluntad y control del VENDEDOR no es posible el cumplimiento en la fecha de entrega acordada o si el COMPRADOR cambia el pedido original o se retrasa en sus obligaciones contractuales.

7. INCUMPLIMIENTO EN LA ENTREGA O EN LA RECEPCIÓN: Si el comprador no recoge las MERCANCIAS, total o parcialmente, en las fechas y lugares acordados el VENDEDOR podrá, a su elección, cancelar dicha entrega y cualesquiera otras pendientes, repercutiendo al comprador todas las pérdidas sufridas; o almacenar las MERCANCIAS por cuenta, coste y riesgo del COMPRADOR.

8. ACEPTACIÓN DE MERCANCÍA: El COMPRADOR revisará y llevará a cabo el reconocimiento de las MERCANCIAS, en cuanto a calidad y cantidad, en el acto mismo de la entrega. Una vez revisada la MERCANCÍA, ésta se considerará aceptada por el COMPRADOR, que renuncia a cualquier reclamación.

9. RESERVA DE DOMINIO: El VENDEDOR conservará la propiedad de las MERCANCIAS suministradas hasta la recepción completa de los pagos acordados con el COMPRADOR. En el supuesto de que el COMPRADOR incumpla cualquiera de sus obligaciones de pago, el VENDEDOR estará facultado para recuperar directamente la posesión de las MERCANCIAS, retirándolas del lugar en el que se encuentren depositadas, sin necesidad de mediar resolución judicial.

10. DESCRIPCIÓN Y GARANTÍAS: El VENDEDOR garantiza que en la fecha de entrega las MERCANCIAS son, según su leal saber y entender, conformes con las especificaciones acordadas en el pedido. Quedan excluidas de la garantía y responsabilidad del VENDEDOR todas aquellas faltas de conformidad que se hallen fuera de su control. Quedan asimismo excluidas de garantía las MERCANCIAS en las que el COMPRADOR o un tercero hubieran realizado o iniciado reparaciones, modificaciones o ajustes sin el consentimiento previo del VENDEDOR. Las condiciones concretas de garantía frente al CONSUMIDOR final se entregan al COMPRADOR junto con la propia MERCANCÍA.

11. DAÑOS Y LÍMITE DE RESPONSABILIDAD: Las reclamaciones de garantía y responsabilidad están exclusivamente cubiertas por estas CONDICIONES. Salvo lo dispuesto en leyes imperativas, el VENDEDOR no responderá de ningún daño contractual ni extracontractual, como por ejemplo los resultantes de pérdidas de producción, de uso, de pedidos, de beneficios (incluido el lucro cesante), o cualquier otro daño directo, indirecto o consecuencial. Salvo acuerdo en contrario, la responsabilidad del VENDEDOR por los daños y perjuicios que el COMPRADOR pueda sufrir nunca excederá del valor de las MERCANCIAS afectadas en el momento de la venta. Los precios del VENDEDOR son elaborados y negociados sobre la base de que su responsabilidad legal máxima estará limitada. Si así lo solicita el COMPRADOR, el VENDEDOR podrá negociar unos límites de responsabilidad más altos, sujetos al correspondiente incremento proporcional del precio. El VENDEDOR no será responsable de los daños y perjuicios que

el COMPRADOR pueda sufrir como consecuencia de sus actos u omisiones, o de sus empleados y representantes en relación al CONTRATO o la MERCANCÍA, que excedan del importe del precio de compra de ésta y, en su caso, de la instalación si hubiera sido llevada a cabo por el VENDEDOR, excluyendo el IVA, derechos de aduana, primas de seguro y otros costes distintos de los de la Mercancía misma.

12. FUERZA MAYOR: Se producirá Fuerza Mayor, a los efectos de las presentes CONDICIONES, cuando exista cualquier contingencia, circunstancia o causa fuera del control de la parte que la invoca. Si por Fuerza Mayor cualquiera de las Partes no puede cumplir alguna obligación contractual distinta a la de pago del precio, dicha Parte queda exonerada de su cumplimiento, siempre que lo notifique a la otra parte indicando el comienzo y la naturaleza de la situación de Fuerza Mayor. La Parte que invoque la Fuerza Mayor deberá enviar notificación inmediata tras la finalización de la causa que la hubiere motivado. El VENDEDOR no será responsable frente al COMPRADOR por ninguna pérdida o daño derivado del incumplimiento o de la falta de cumplimiento puntual o total de sus obligaciones por causa de Fuerza Mayor.

13. CONFIDENCIALIDAD Y PROTECCIÓN DE DATOS: Los datos de carácter personal facilitados por el COMPRADOR formarán parte del fichero de clientes del VENDEDOR, cuyos fines son el mantenimiento de la relación contractual, el control y gestión de las ventas y sus correspondientes cobros, y eventualmente, el envío de información, por cualquier medio, sobre los productos y servicios del VENDEDOR. El VENDEDOR tratará dichos datos con la máxima confidencialidad, y se compromete a no utilizarlos con un fin distinto a aquél para el que han sido recabados, así como a conservarlos con las debidas medidas que garanticen su seguridad y eviten su alteración, pérdida, tratamiento o acceso no autorizados. El COMPRADOR tiene la posibilidad de ejercitar los derechos de acceso, rectificación, cancelación y oposición dirigiendo una comunicación por escrito al domicilio del VENDEDOR a la atención del Responsable de Protección de Datos.

14. IDIOMA: En caso de discrepancia entre textos en castellano y textos en cualquier otra lengua del CONTRATO o de cualquier otra documentación referida a la venta de la MERCANCÍA, prevalecerá el texto en castellano.

15. LEY APLICABLE Y JURISDICCIÓN COMPETENTE: Cualquier CONTRATO sometido a estas CONDICIONES se regirá e interpretará de conformidad con las leyes españolas. Las PARTES renuncian expresamente a cualquier foro o jurisdicción a los que pudiesen tener derecho, y acuerdan someter a los Juzgados y Tribunales de la ciudad de Sabadell (Barcelona, España) cualquier diferencia o litigio derivados de la validez, interpretación, cumplimiento o ejecución del CONTRATO, las Condiciones Generales de Venta, así como de los actos o transacciones contemplados en las mismas.

Product guarantee

1. This guarantee applies only to sales made to consumers.

2. In accordance with these provisions, SACOPA, S.A.U. as owner of the mark IGNIALIGHT (“The Manufacturer”) hereby guarantees that the product corresponding to this guarantee OnLED Underwater, Architectural Lighting, Decorative Lighting, Control Devices and LEDs “Light Emitting Diode” (“the Product”) does not contain whatsoever non-conformity when it is delivered.

3. The delivery of the Product does not include installation. The Manufacturer hereby declines whatsoever responsibility for the incorrect or faulty installation of the Product.

4. Without prejudice to those products that carry an additional commercial guarantee as indicated in point 13, the Legal Guarantee Period for the product is two years, following its delivery to the consumer. Completed delivery will be considered as that made on the date that appears on the proof of purchase on the corresponding invoice or on the delivery note if this was made later. For this guarantee to be effective, the consumer must provide proof that the Product is under guarantee by presenting the supporting documents for the acquisition or delivery of the goods referred to.

5. If, during the Legal Term of Guarantee, the consumer were to report a non-conformity of the Product attributable to the origin, identity or suitability of the Product in accordance with its nature, purpose and applicable regulations and should he demonstrate that the Product is under warranty, the seller will repair or replace the Product on his own account in the place he considers appropriate, unless it is impossible or disproportionate.

6. When the Product cannot be repaired or replaced, the consumer may request a proportional reduction of the price or, if the non-conformity makes the Product unusable for its purpose, the termination of the contract of sale.

7. The parts repaired or replaced by virtue of this guarantee will not extend the term of guarantee for the original Product; however, they will be covered by their own guarantee.

8. Six months after the purchase of the Product,

the consumer who reports a non-conformity must demonstrate the origin and existence of the fault that is reported.

9. This Certificate of Guarantee does not limit or prejudice the rights that correspond to consumers by virtue of mandatory national legislation.

10. For this guarantee to be effective, the consumer must demonstrate that he has followed the Manufacturer’s instructions and indications to the letter as provided on the documentation delivered with the Product, when they are applicable in accordance with the range and model of the Product, including the calendar for the replacement, maintenance and cleaning of the parts and components of the product.

11. The guarantee excludes faults and deterioration caused by the following:

- Negligence, lack of due care, handling, transport or use of the product.

- Inappropriate environments or conditions: as an information and not as a limitation, the Manufacturer indicates that environments or conditions will be considered inappropriate if the functioning is in environments with a temperature upper to the 40 Centigrade degrees. And, in the case of swimming pools, the treatments of cleaning of swimming pools that exceed the following conditions :

Swimming pool treatment, chlorine (Cl) : 2 gr/l

Swimming pool treatment, bromine (Br) : 5 gr/l

Swimming pool treatment, salt electrolysis (Na Cl + Vdc) : 6 gr/l (Vdc 24 V)

pH : between 7,2 and 7,6

- Failure to follow the Manufacturer’s indications and the specifications given in the instructions, warnings or whatsoever other documentation provided with the Product.

- Insufficient or inappropriate maintenance of the environmental conditions and of the Product.

- Partial or full modifications to the Product without prior authorisation in writing from the Manufacturer.

- Causes of force majeure, fire, frosts, flooding, lightning or whatsoever other unforeseen disaster of whatsoever origin.

- Causes beyond the scope of or external to the Product, such as its storage outdoors or in closed places with chemical products, which may give rise to adverse ambient conditions.

- The uncontrolled discharge of chemical products or

agents onto the Product.

- In the case of underwater leds lighting: Electrical escapes of any product in contact with the water of the installation.

- Those which, although not included in the foregoing, may be excluded owing to the fact that they cannot be attributed to a material fault or to the manufacturing process.

12. The guarantee also excludes the Products on which the consumer or whatsoever third party has completed or started repair work, modifications or adjustments without the Manufacturer’s prior consent.

13. ADDITIONAL COMMERCIAL GUARANTEE The additional commercial guarantee period of the PAR56 OnLED products will be of one year (1), counting from the end date of the legal guarantee period of two years. The LED (Light-Emitting Diode) used in all the range of SACOPA products will have an additional commercial guarantee of 3 years (3). This additional commercial guarantee will be applicable all over the world. For the application of this commercial guarantee all the necessary requirements for the application of the legal guarantee must be accomplished, these requirements are indicated in the Guarantee Certificate supplied with the product. The consumer must directly contact the manufacturer, at the indicated address, providing the proof of purchase and payment of the product, where necessarily must appear a date of this purchase. Any claim that does not meet these requirements will not be accepted.

In case of lack of conformity, as long as all the mentioned requirements are fulfilled, the Manufacturer, as its choice, will proceed to repair or replace the product. The additional guarantee in any case does not cover the shipping costs or manpower. These costs will be communicated (with its approximated value) to the customer for its acceptance, and should be paid, in all cases, by the customer. In case of non-conformity that is caused by an installation error or any other cause that is not attributable to the Manufacturer, the consumer is obligated to pay all the expenses incurred in order to diagnose the problem (e.g. traveling expenses, manpower, etc.) justified by the corresponding invoices. In case of this guarantee the same general exclusions are applied as in case of the Guarantee Certificate, supplied with the product.



Garantía de producto

1. Esta garantía sólo se aplica a ventas realizadas a consumidores.

2. De acuerdo con estas disposiciones, SACOPA, S.A.U en calidad de propietario de la marca IGNIA-LIGHT (en adelante “el Fabricante”) garantiza que el producto correspondiente a esta garantía proyectores subacuáticos OnLED, Proyectores arquitectónicos, Iluminación decorativa, dispositivos de control y Diodos LED “Diodo Emisor de Luz” en adelante (“el Producto”) no presenta ninguna falta de conformidad en el momento de su entrega.

3. La entrega del Producto no incluye instalación. El Fabricante no asume responsabilidad por la incorrecta o defectuosa instalación del mismo.

4. Sin perjuicio de aquellos productos que tengan una garantía comercial adicional tal y como se indica en el punto 13, el Periodo de Garantía Legal para el producto es de dos años, contados a partir de su entrega al consumidor. Se entenderá realizada la entrega en la fecha que figure en el justificante de compra, en la factura correspondiente o en el albarán de entrega si ésta fuera posterior. Para la efectividad de la presente garantía, el consumidor deberá acreditar que el Producto se encuentra en garantía mediante la exhibición de la documentación acreditativa de la adquisición o entrega a la que se ha hecho referencia.

5. Si, durante el Periodo de Garantía Legal, el consumidor notificara una falta de conformidad del Producto imputable al origen, identidad o idoneidad del producto de acuerdo con su naturaleza, finalidad y con las normas que le sean aplicables, y acreditara que el producto está en garantía, el vendedor reparará o sustituirá el Producto a su propio coste en el lugar donde considere oportuno, salvo que ello sea imposible o desproporcionado.

6. Cuando no se pueda reparar o sustituir el Producto, el consumidor podrá solicitar una reducción proporcional del precio o, si la falta de conformidad convirtiera al producto en inhábil para el fin a que se destina, la resolución del contrato de venta.

7. Las partes sustituidas o reparadas en virtud de esta garantía no ampliarán el plazo de la garantía del Producto original, si bien dispondrán de su propia garantía.

8. Transcurridos seis meses desde la adquisición del Producto, el consumidor que alegue falta de conformidad deberá acreditar el origen y la existencia del defecto alegado.

9. El presente Certificado de Garantía no limita o prejuzga los derechos que correspondan a los consumidores en virtud de normas nacionales de carácter imperativo.

10. Para la eficacia de esta garantía, el consumidor deberá acreditar que ha cumplido estrictamente las indicaciones e instrucciones del Fabricante incluidas en la documentación que acompaña al Producto, cuando éstas resulten aplicables según la gama y modelo del Producto, incluido el calendario para la sustitución, mantenimiento o limpieza de piezas o componentes del producto.

11. Quedan excluidos de la garantía los desperfectos o deterioros debidos a:

- Negligencias o imprudencias de instalación, manipulación, transporte o uso del producto.
- Ambientes o condiciones inadecuados: a título informativo y no limitativo el Fabricante advierte que se considerarán ambientes o condiciones inadecuadas el funcionamiento en ambientes con una temperatura ambiental superior a los 40º C, y en el caso de piscinas, los tratamientos de limpieza de piscina que superen las siguientes condiciones:
Tratamiento piscina, cloro (Cl) : 2 g/l
Tratamiento piscina, bromo (Br) : 5 g/l
Tratamiento piscina, electrolisis de sal (Na Cl + Vcc) : 6 g/l (Vcc 24 V)
pH : entre 7,2 y 7,6
- Falta de cumplimiento de las indicaciones del Fabricante y de lo especificado en las instrucciones, advertencias o cualquier otra documentación que acompañe al Producto.
- Mantenimiento insuficiente o inadecuado, tanto de las condiciones ambientales, como del Producto.
- Modificaciones totales o parciales del producto, sin autorización previa escrita por el fabricante.
- Causas de fuerza mayor, incendios, heladas, inundaciones, rayos o cualquier otra catástrofe imprevista de cualquier origen.
- Causas ajenas o externas al Producto, como su almacenamiento a la intemperie o en lugares cerrados conjuntamente con productos químicos, donde puedan existir unas condiciones ambientales adversas.
- El vertido incontrolado sobre el Producto de agentes o productos químicos.
- En el caso de leds subacuáticos: Fugas eléctricas de cualquier producto en contacto con el agua de la instalación
- Aquéllos que, sin estar contemplados en los puntos anteriores, puedan ser excluidos por no ser imputables ni a un defecto del material, ni a su proceso de fabricación.

12. Quedan asimismo excluidos de garantía los Productos en los que el consumidor o un tercero hubieran realizado o iniciado reparaciones, modificaciones o ajustes sin el consentimiento previo del Fabricante.

13. GARANTÍA COMERCIAL ADICIONAL: El plazo de duración de la garantía comercial adicional de los productos OnLED PAR56 será de un año (1), contado desde la fecha de finalización del plazo de garantía legal de dos años. Los LED (Diodos Emisor de Luz) utilizados en toda la gama de productos de SACOPA tendrán una garantía comercial adicional de 3 años (3). La presente garantía comercial adicional será de aplicación en todo el mundo. Para la aplicación de la presente garantía comercial deberán cumplirse todos los requisitos necesarios para que resulte de aplicación la garantía legal, indicados en el Certificado de Garantía entregado junto con el producto. El consumidor deberá dirigirse directamente al fabricante, en el domicilio indicado, aportando el comprobante de compra y pago del producto, donde necesariamente debe figurar la fecha de adquisición del mismo. No se admitirá ninguna reclamación que no cumpla estos requisitos.

En caso de falta de conformidad, siempre y cuando se cumplan todos los requisitos aquí mencionados, el Fabricante procederá, a su libre elección, a reparar o sustituir el Producto. La garantía adicional no cubre en ningún caso los gastos de transporte, ni la mano de obra, que se comunicarán –siquiera de forma aproximada- al consumidor para su aceptación, y que deberán ser satisfechos en todo caso por éste. En caso de que la no-conformidad se debiera a un error en la instalación o a cualquier otra causa no imputable al Fabricante, el consumidor se obliga a abonar todos los gastos incurridos para diagnosticar el problema (a título meramente ejemplificativo: desplazamientos, mano de obra, etc.) justificados mediante las correspondientes facturas. Resultan de aplicación las mismas exclusiones generales contenidas en el certificado de Garantía entregado junto con el producto. ma aproximada- al consumidor para su aceptación, y que deberán ser satisfechos en todo caso por éste. En caso de que la no-conformidad se debiera a un error en la instalación o a cualquier otra causa no imputable al Fabricante, el consumidor se obliga a abonar todos los gastos incurridos para diagnosticar el problema (a título meramente ejemplificativo: desplazamientos, mano de obra, etc.) justificados mediante las correspondientes facturas. Resultan de aplicación las mismas exclusiones generales contenidas en el certificado de Garantía entregado junto con el producto.

Rev.06 © 2024 IGNIALIGHT Todos los derechos reservados/ *All rights reserved*

Reservados todos los derechos. El contenido de esta publicación no puede ser total ni parcialmente reproducido, transmitido ni registrado por ningún sistema de recuperación de información, de ninguna forma ni a través de ningún medio o soporte, sin el previo consentimiento por escrito de los titulares del copyright. IGNIALIGHT no se hace responsable del uso que de esta información pueden hacer terceras personas. Nadie puede hacer uso de este material salvo autorización expresa por parte de IGNIALIGHT. No se presta garantía alguna respecto a la exactitud o integridad de la información contenida en el mismo, en la medida legalmente permitida.

All rights reserved. The contents of this document cannot be totally or partially reproduced, transmitted or registered by any data recovery system, in any way or through any means or support, without the prior consent in writing of the copyright owners. IGNIALIGHT will not be held responsible for the use that third parties may make of this information. It is prohibited for anyone to make use of this material without the express authorisation from IGNIALIGHT. No guarantee is lent with respect to the exactitude or integrity of the information contained in this catalog, in the legally allowed.

ignialight.com

